

Legal Filing
Solutions

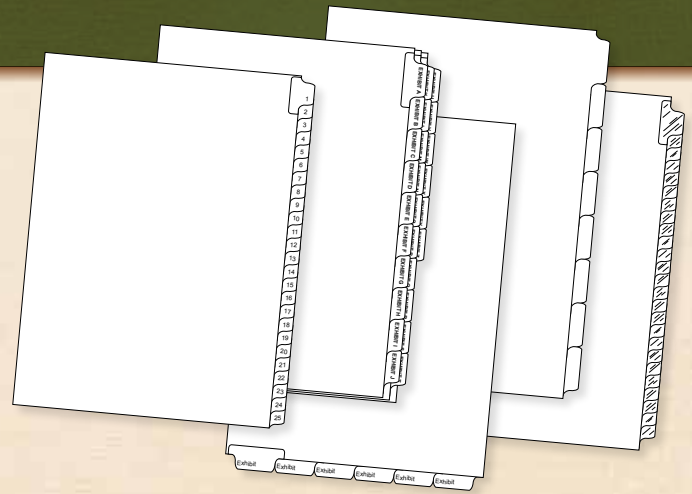



Table of Contents

Indexes

All-State® Style _____	3-4
Avery® Style _____	5-6
Blank _____	7
Miscellaneous _____	8
Write-In Exhibit _____	8
Dividers and Filebacks _____	9
Writable Divider Tabs _____	9
Custom Options _____	10



Folders and Pockets

Expandable File Pockets _____	11-14
Wallets _____	14
Label Bands _____	14
End Tab _____	15-16
Top Tab _____	16
Pockets _____	16
Classification _____	17
Presentation _____	18
Binders and Report Covers _____	18
Patent/Trademark Application _____	19
Simplyfile _____	20



Accessories

Fasteners _____	21
Accessories _____	21
Folder Pockets _____	21
Outguides _____	22
End Tab Converters _____	22
Charge-Out Slips _____	22



Labels

Alphabetic _____	23-24
Numeric _____	25
Solid Color _____	25
Exhibit _____	26
Year/Month _____	26-28
Name _____	29
Label Protectors _____	30



All-State® Style Indexes

- Sold as individual packages or collated sets
- Printed on 80lb White stock
- Clear mylar laminated tabs
- Printed on both sides, in both directions

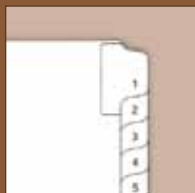

- Typeface is small and light

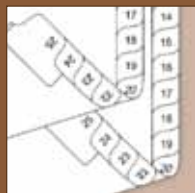

- Backside is either upside down or right-side up

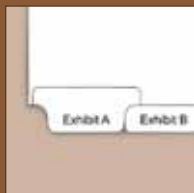

- Bottom exhibit tabs are 6 tabs/bank
- "Exhibit" is both upper and lower case

Collated Sets

11" Letter Size

ITEM NO.	TITLE	TAB
AS-11SN-C1 (1-25) to AS-11SN-C976 (976-1000)	1-1000	SIDE
AS-11SN-CR1 (1-25) to AS-11SN-CR76 (76-100)	1-100 (back copy printed right-side up)	SIDE
AS-11SA-AZ	A-Z	SIDE
AS-11SA-AAZZ	AA-ZZ	SIDE
AS-11SRNI-X	I-X	SIDE
AS-11SRNI-XX	I-XX	SIDE
AS-11SEN-C1 (1-25) to AS-11SEN-C76 (76-100)	Exhibit 1-100	SIDE
AS-11SEA-AZ	Exhibit A-Z	SIDE
AS-11BN-C1 (1-25) & AS-11BN-C26 (26-50)	1-50	BOTTOM
AS-11BA-AZ	A-Z	BOTTOM
AS-11BEN-C1 (1-24) & AS-11BEN-C25 (25-48)	Exhibit 1-48	BOTTOM
AS-11BEA-AZ	Exhibit A-Z	BOTTOM

14" Legal Size

AS-14SN-C1 (1-25) to AS-14SN-C226 (226-250)	1-250	SIDE
AS-14SA-AZ	A-Z	SIDE
AS-14SEA-AZ	Exhibit A-Z	SIDE

Legal size is not pictured for sets or packages.

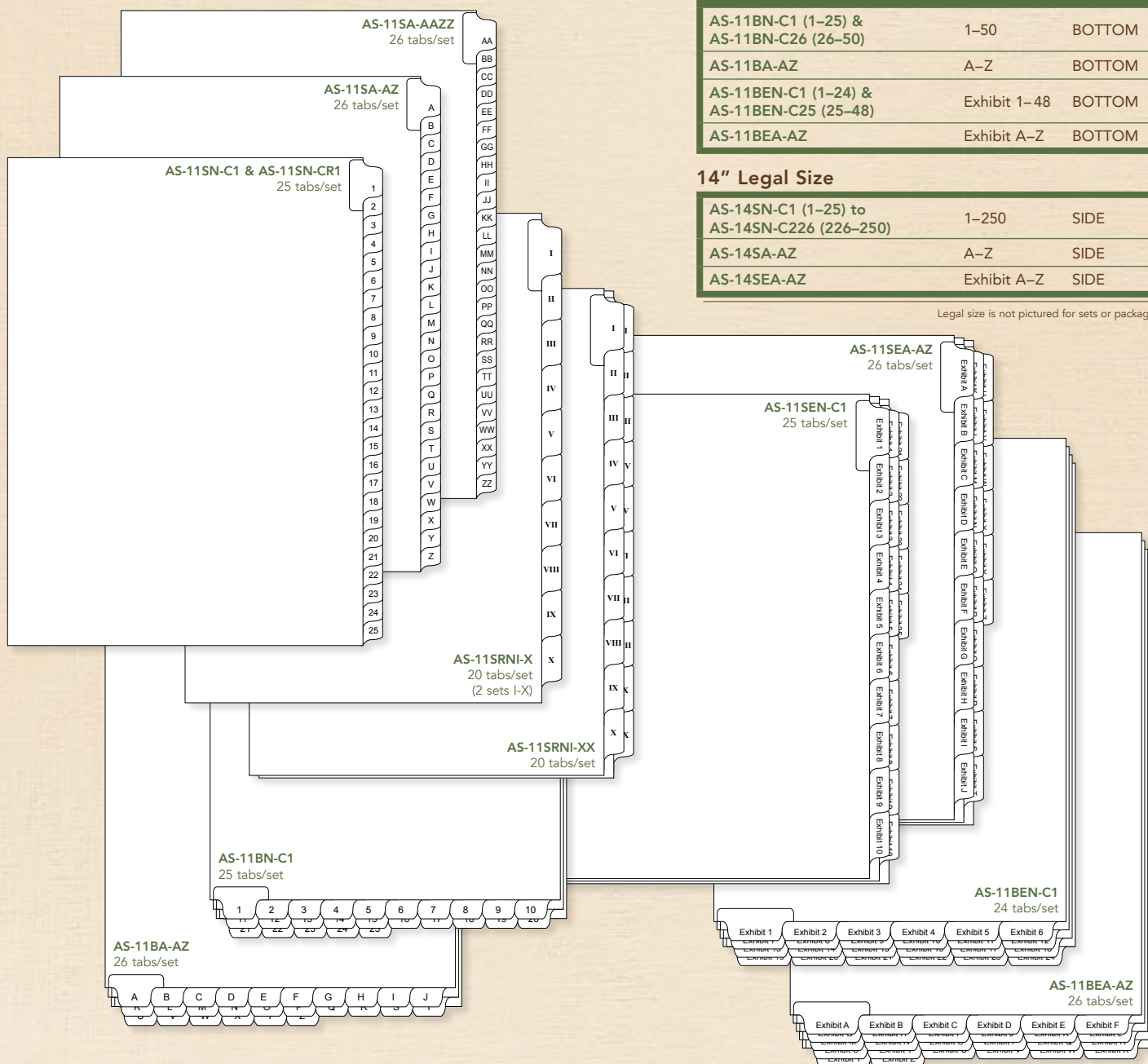

Individual Packages

11" Letter Size (25 SHEETS/PKG)

ITEM NO.	TITLE	TAB
AS-11SN-1 to AS-11SN-50	1-50	SIDE
AS-11SA-A to AS-11SA-Z	A-Z	SIDE
AS-11SEN-1 to AS-11SEN-25	Exhibit 1-25	SIDE
AS-11SEA-A to AS-11SEA-Z	Exhibit A-Z	SIDE
AS-11BEN-1 to AS-11BEN-50	Exhibit 1-50	BOTTOM
AS-11BEA-A to AS-11BEA-Z	Exhibit A-Z	BOTTOM

14" Legal Size (25 SHEETS/PKG)

AS-14SN-1 to AS-14SN-50	1-50	SIDE
AS-14SA-A to AS-14SA-Z	A-Z	SIDE
AS-14SEA-A to AS-14SEA-Z	Exhibit A-Z	SIDE

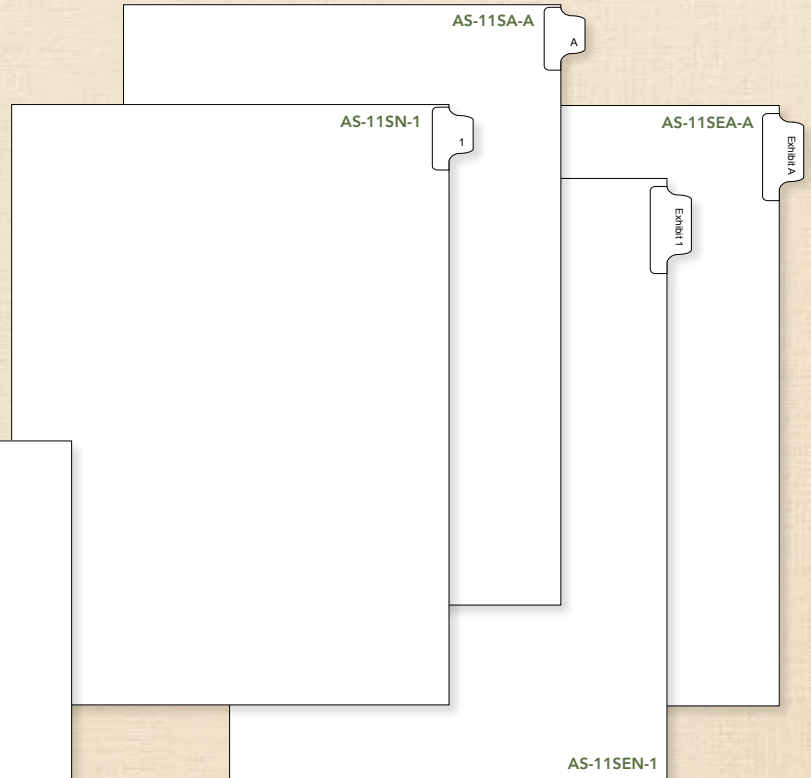

Expandable File Pockets

Pair your indexes with our durable line of Expandable File Pockets, and you'll never lose a file again! (pages 11-14)



Don't forget to order your Label Bands! (page 14)

Avery® Style Indexes

- Sold as individual packages or collated sets
- Printed on 80lb White stock
- Clear mylar laminated tabs
- Printed on both sides, backside is upside down

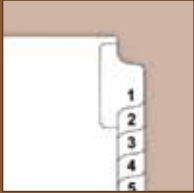

• Typeface is bold



• Backside is upside down



• Bottom exhibit tabs are 5 tabs/bank
• "EXHIBIT" is all upper case

Collated Sets

11" Letter Size

ITEM NO.	TITLE	TAB
AV-11SNA-C1 (1-25) to AV-11SNA-C76 (76-100)	1-100	SIDE
AV-11SNB-C101 (101-125) to AV-11SNB-C276 (276-300)	101-300	SIDE
AV-11SNC-C301 (301-325) to AV-11SNC-C976 (976-1000)	301-1000	SIDE
AV-11SND-C1001 (1001-1025) to AV-11SND-C4976 (4976-5000)	1001-5000	SIDE
AV-11SNE-C5001 (5001-5025) to AV-11SNE-C7976 (7976-8000)	5001-8000	SIDE
AV-11SA-AZ	A-Z	SIDE
AV-11SA-AAZZ	AA-ZZ	SIDE
AV-11SA-AAZZZ	AAA-ZZZ	SIDE
AV-11SEN-C1	Exhibit 1-25	SIDE
AV-11SEA-AZ	Exhibit A-Z	SIDE
AV-11BEN-C1	Exhibit 1-25	BOTTOM
AV-11BEA-AZ	Exhibit A-Z	BOTTOM

14" Legal Size

AV-14SN-C1 (1-25) to AV-14SN-C476 (476-500)	1-500	SIDE
---	-------	------

Legal size is not pictured for sets or packages.

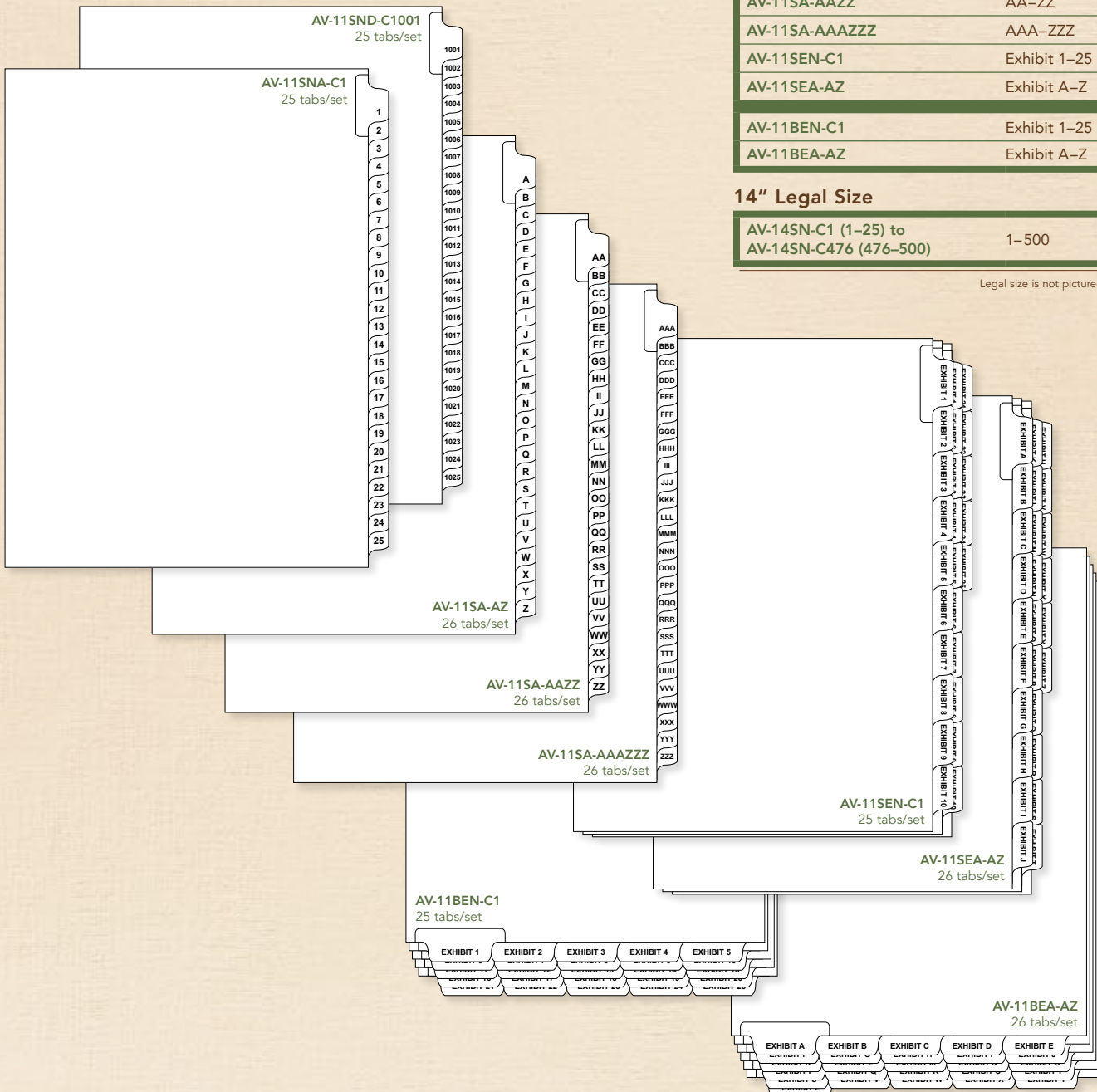

Individual Packages

11" Letter Size (25 SHEETS/PKG)

ITEM NO.	TITLE	TAB
AV-11SN-1 to AV-11SN-225	1-225	SIDE
AV-11SA-A to AV-11SA-Z	A-Z	SIDE
AV-11SEN-1 to AV-11SEN-100	Exhibit 1-100	SIDE
AV-11SEA-A to AV-11SEA-Z	Exhibit A-Z	SIDE
AV-11BEN-1 to AV-11BEN-100	Exhibit 1-100	BOTTOM
AV-11BEA-A to AV-11BEA-Z	Exhibit A-Z	BOTTOM

14" Legal Size (25 SHEETS/PKG)

AV-14SN-1 to AV-14SN-100	1-100	SIDE
--------------------------	-------	------

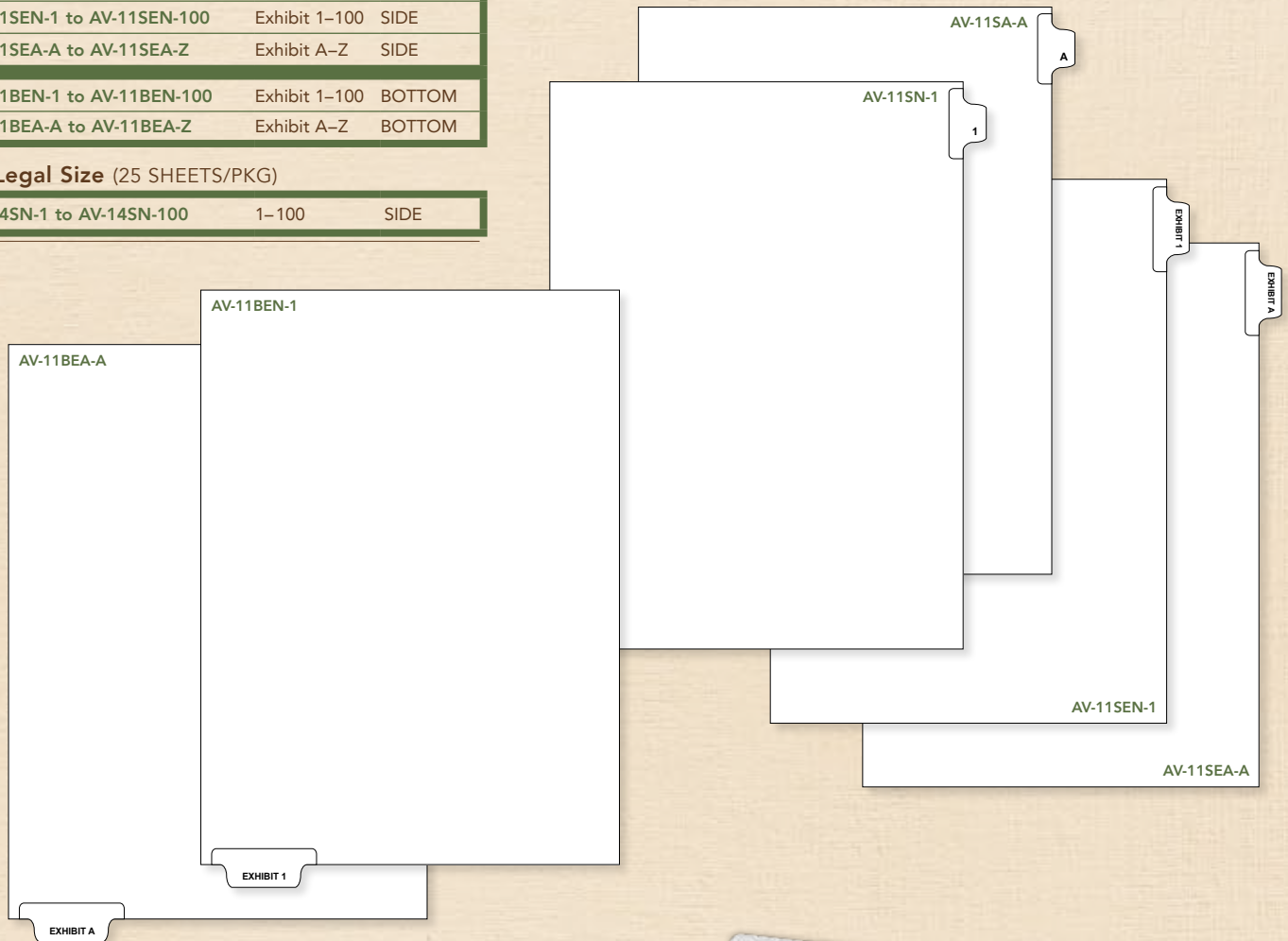

Need specific indexes?
Check out the custom options!
(page 10)

Customized Classification Folders

Divide and organize your information in style. Indexes work great when combined with custom classification folders! (page 17)



Blank Indexes

Our blank tabs are non-laminated and made of extra-durable 90lb White stock.

Collated Sets

11" Letter Size

ITEM NO.	TABS/SET	TAB
BLANK-11S-5	5	SIDE
BLANK-11S-8	8	SIDE
AV-BLANK-11S-25	25	SIDE
AV-BLANKL-11S-25*	25	SIDE
BLANK-11B-5	5	BOTTOM
BLANK-11B-6	6	BOTTOM

14" Legal Size

BLANK-14S-6	6	SIDE
BLANK-14B-6	6	BOTTOM

Legal size is not pictured.

*Laminated Avery®-match tab set is reinforced with a clear mylar material and made from 80lb White stock.

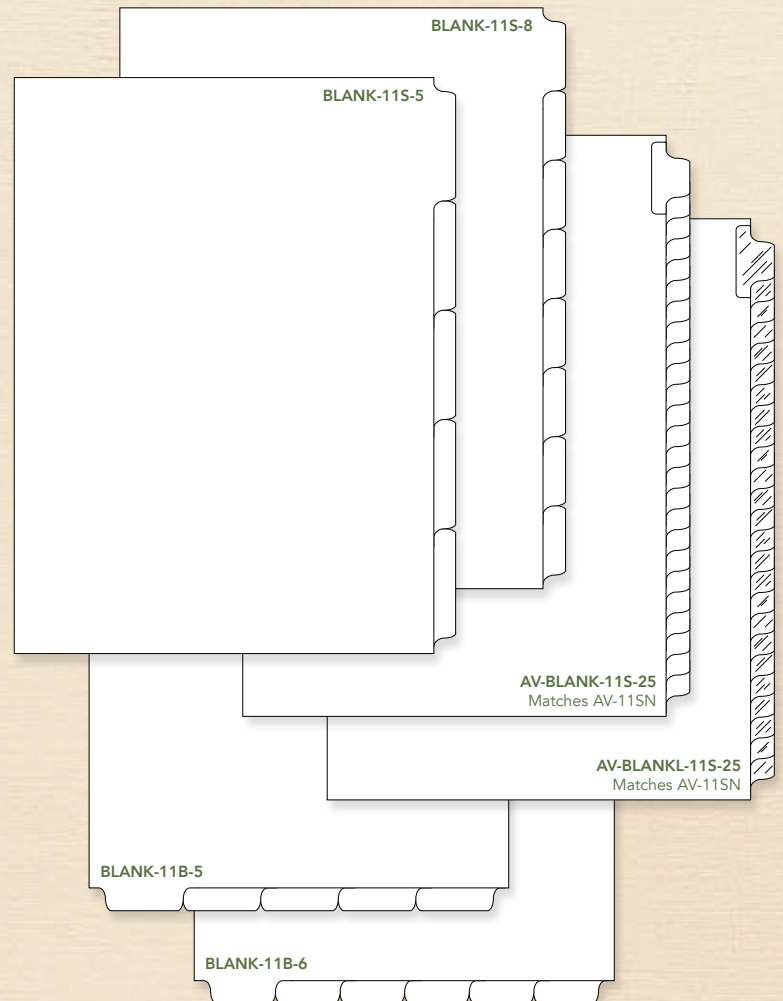

Patent and Trademark Application Folders

Three stock Patent and Trademark Application folders to choose from. Or customize your own! (page 19)

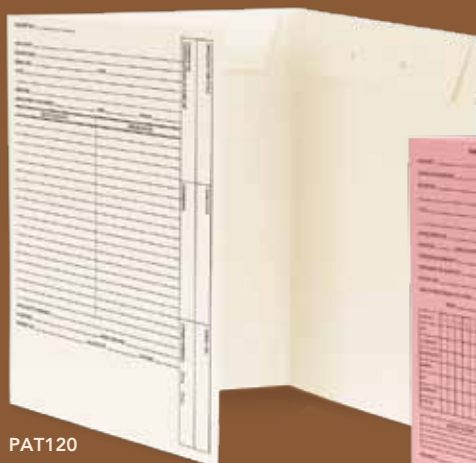

PAT120

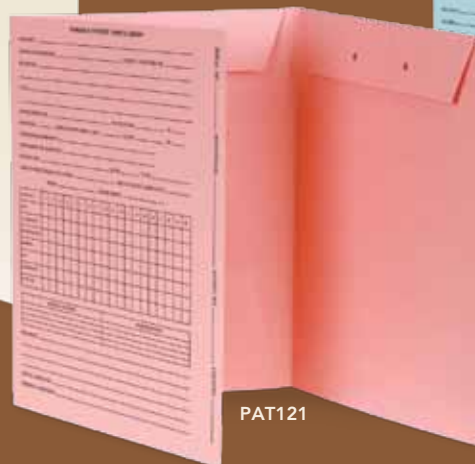

PAT121



PAT122

Miscellaneous Indexes

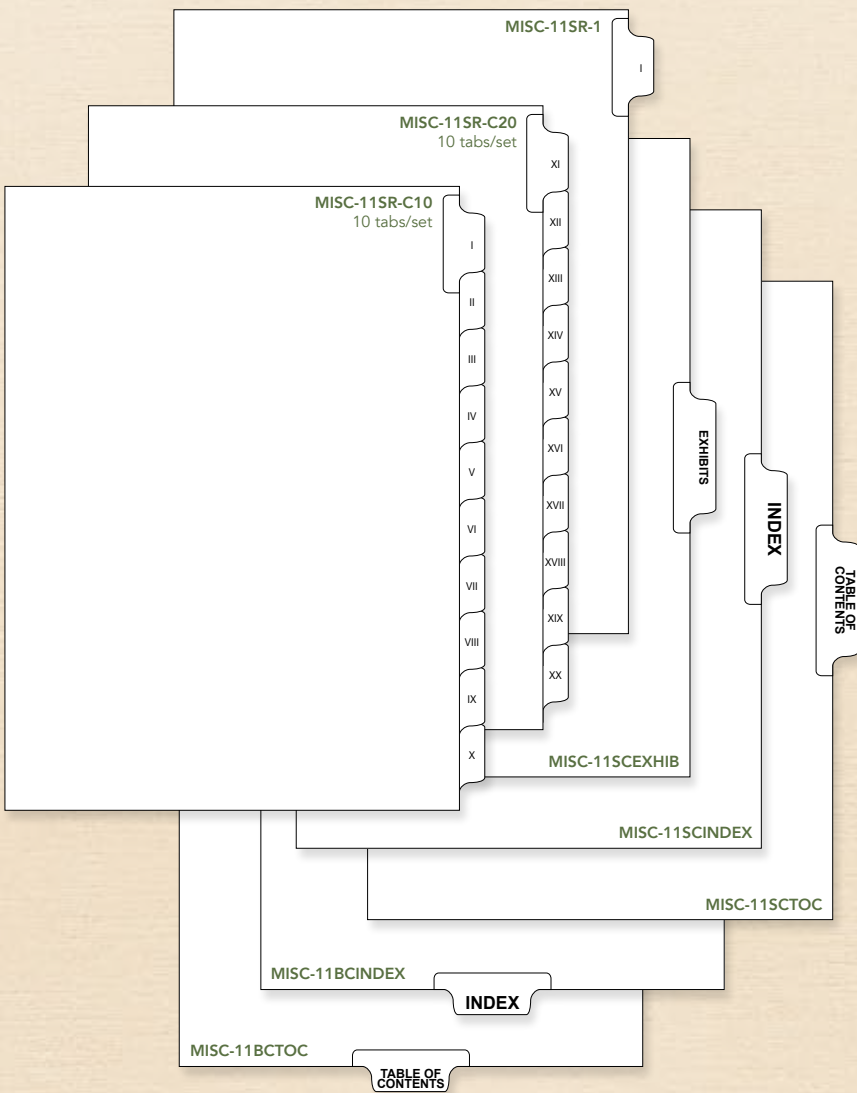

Collated Sets

11" Letter Size 80lb White

ITEM NO.	TITLE	TAB
MISC-11SR-C10	Roman Numerals I-X	SIDE
MISC-11SR-C20	Roman Numerals XI-XX	SIDE

Individual Packages

11" Letter Size (25 SHEETS/PKG) 80lb White

ITEM NO.	TITLE	TAB
MISC-11SR-1 to MISC-11SR-20	Roman Numerals I-XX	SIDE
MISC-11SCEXHIB	Exhibits	SIDE CNTR
MISC-11SCINDEX	Index	SIDE CNTR
MISC-11SCTOC	Table of Contents	SIDE CNTR
MISC-11BCINDEX	Index	BTM CNTR
MISC-11BCTOC	Table of Contents	BTM CNTR

14" Legal Size (25 SHEETS/PKG) 80lb White

MISC-14SCINDEX	Index	SIDE CNTR
MISC-14SCTOC	Table of Contents	SIDE CNTR
MISC-14BCINDEX	Index	BTM CNTR
MISC-14BCTOC	Table of Contents	BTM CNTR

Legal size is not pictured.

WRITE-IN EXHIBIT

Collated Sets

11" Letter Size 80lb White

ITEM NO.	TITLE	TAB
MISC-11SEW	Write-In Exhibit 1-10	SIDE
MISC-11BEXW6	Write-In Exhibit 1-6	BOTTOM

Individual Packages

11" Letter Size (25 SHEETS/PKG) 80lb White

ITEM NO.	TITLE	TAB
MISC-11SEW-1 to MISC-11SEW-10	Write-In Exhibit 1-10	SIDE
MISC-11BEXW6-1 to MISC-11BEXW6-6	Write-In Exhibit 1-6	BOTTOM

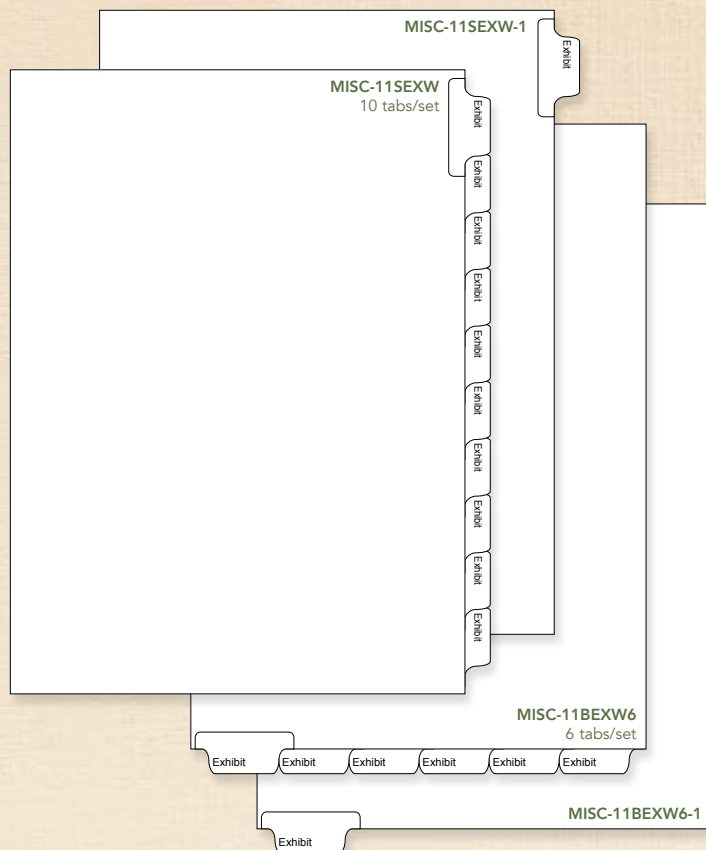

Dividers and Custom Indexes

Chart Divider Sheets

8½" x 11"

Divider sheets are perfect for organizing files and separating them into sections. 110lb White or Manila index stock, two- and three-hole punched for top and side fastener or binder use. Preprinted guidelines for accurate label and/or chart tab application.

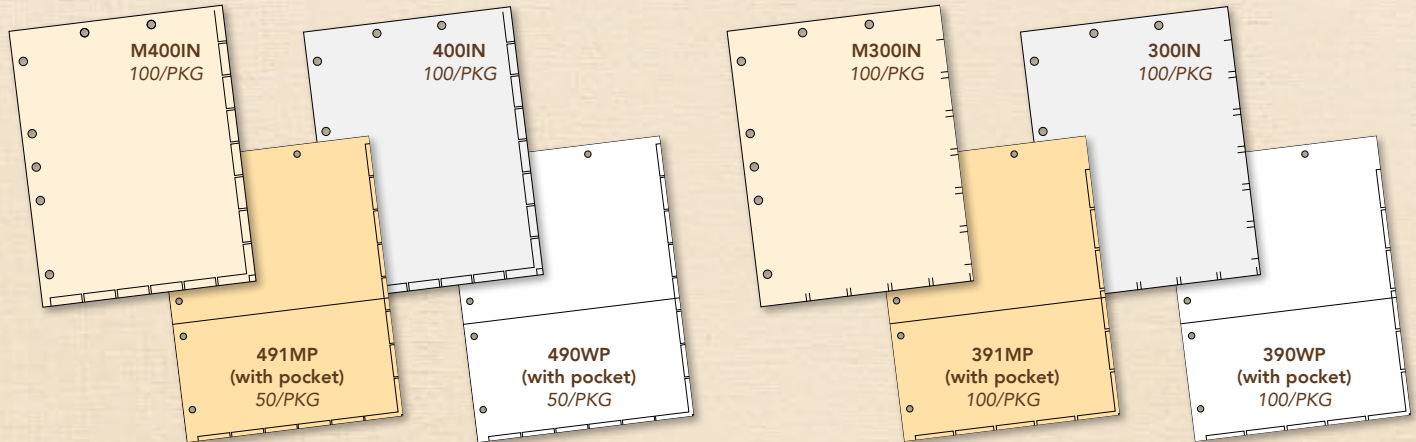

Expanding Fileback Pocket

40lb Kraft Pocket

9½" deep pocket closed on three sides, ¾" expansion. 100/BOX

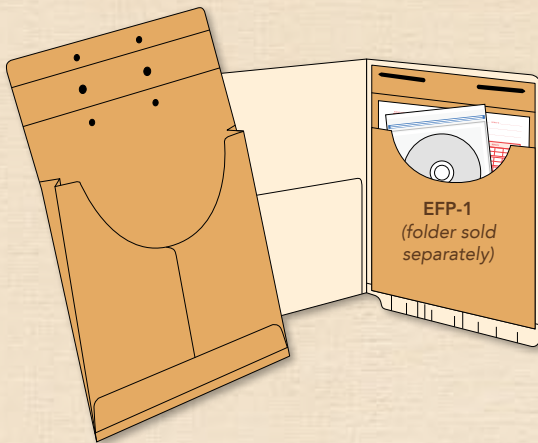

Fileback Dividers

- Add or remove sheets without tearing apart files
- Choose end or side fastener dividers
- Sturdy 11pt Manila stock

Get immediate access to each section of your files without removing top sheets. Just fold on the score line to form the flap, and slip the divider over an existing fastener in the folder. The next divider is attached to the fastener on the first divider, and so on.

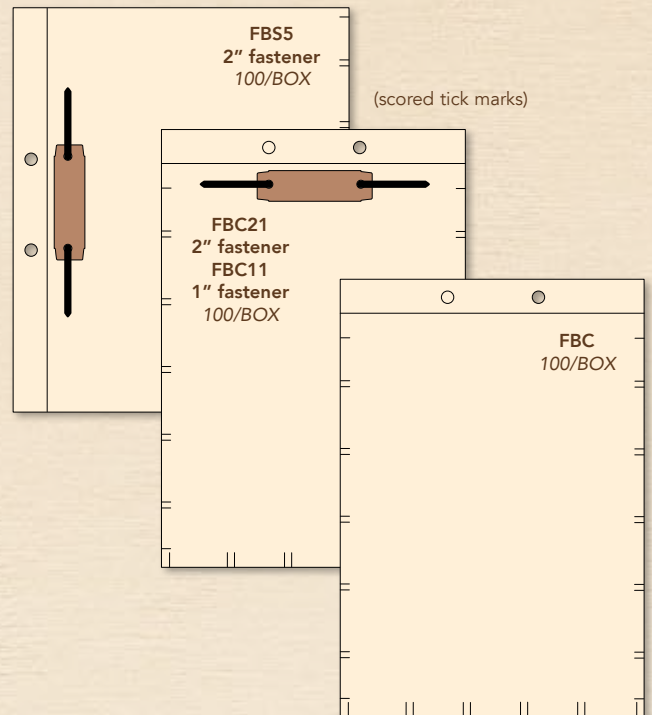

Writable Divider Tabs

1¼" x 1½" before folding

Self-adhesive, laminated tabs with color-coded edges help organize information in files for fast identification. 100/PACK



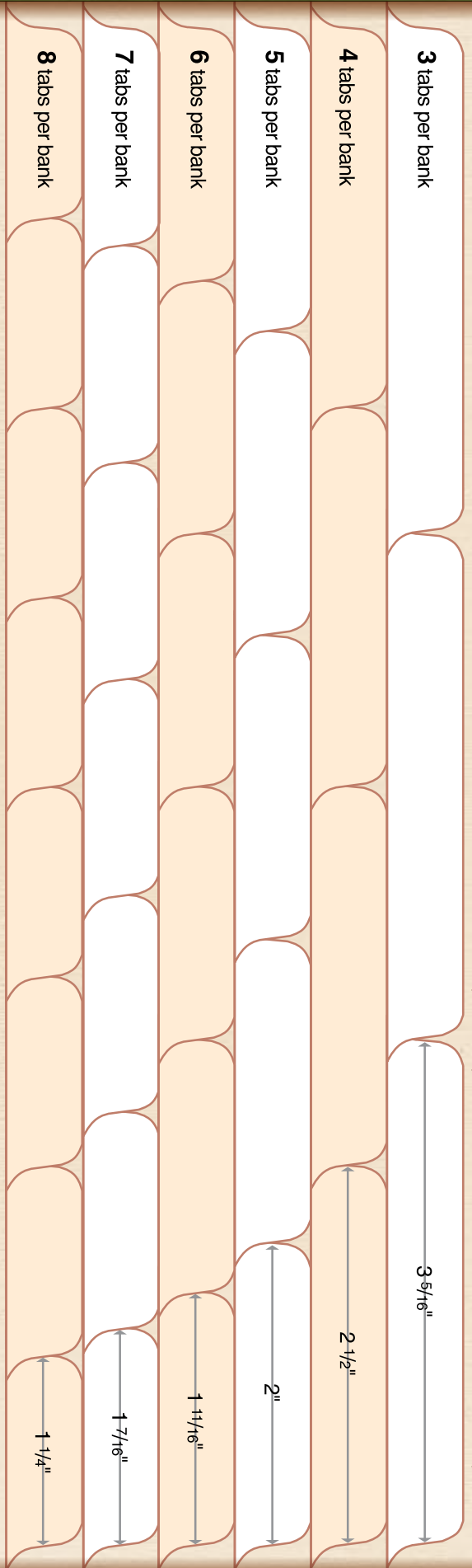

Position 1 starts at the top. Tabs are pictured actual size. Bottom tabs also available (3-7 tabs per bank).

custom indexes... Easy Ordering Steps

- 1 Choose the style of Chart Divider and Paper Color
 - Index Style A–E
 - Stock Color
 - Fileback Style I–III
 - Self-Adhesive Fileback Style (SA)
- 2 Specify tab cut size. See charts at left and below. Plan ahead! Consider leaving an empty position for future use.
- 3 Specify each tab title (text), position, and color. Side tab styles start at the top, and bottom tab styles start at the left.
- 4 Specify packaging:
 - Collated - Titles boxed together in sets (Filebacks are not attached to each other)
 - Not Collated - Titles boxed individually

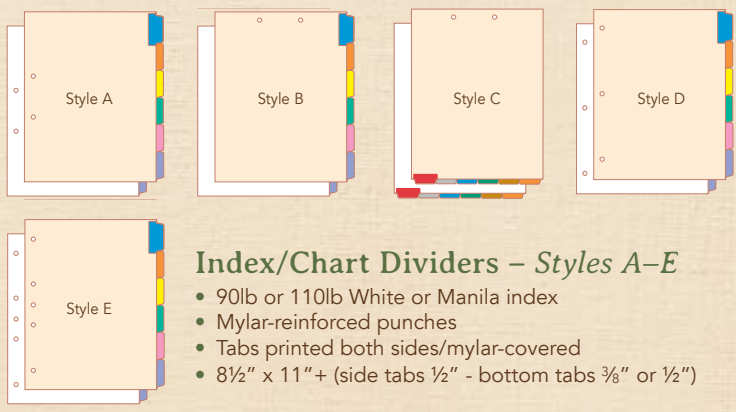

Index/Chart Dividers – Styles A–E

- 90lb or 110lb White or Manila index
- Mylar-reinforced punches
- Tabs printed both sides/mylar-covered
- 8½" x 11"+ (side tabs ½" - bottom tabs ¾" or ½")



Self-Adhesive Filebacks – Style SA

- 110lb Manila index
- 1" scored hinge with ¾" pressure-sensitive tape
- Two pre-installed 2" bonded fasteners (1 each side)
- Tabs printed both sides with different titles/mylar-covered
- 8½" x 11"+ (side tabs ½")

Flip-Up Hinged Filebacks – Styles I–III

- 110lb Manila index
- 1" scored hinge with mylar-reinforced slits
- One pre-installed 2" bonded fastener
- Tabs printed both sides/mylar-covered
- 8½" x 11"+ (side tabs ½" - bottom tabs ¾" or ½")
- Style I and III also available in 8½" x 14"



General specifications are listed on this page. Contact your local sales representative for other options including: body printing, collating, assembly and installation, heavier paper weights and colors, etc.

16 Standard Mylar Tab Colors

Neon colors are available for an additional charge.

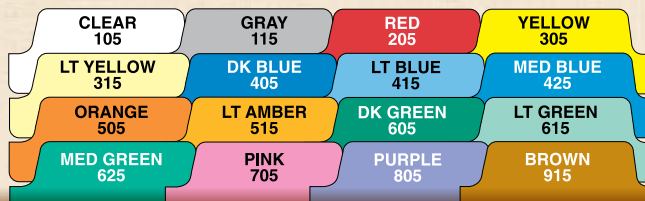

Premium Expandable File Pockets

Premium Pockets

LETTER 9½" H x 11¼" W, LEGAL 9½" H x 14¾" W

Our premium pockets are the strongest in the industry. Made with superior features, they are high-performing products with unmatched professional appearance. Design pairs with durability for guaranteed visual and functional satisfaction.

ALL PREMIUM POCKETS FEATURE:

- 18pt acid-free manila liners
- 11pt premium textured Reprise Red wallet
- 1" rolled edge, 6½" high, Cocoa Swirl Tyvek® gusset



PRM P1211



PRM P1511



PRM P1213



PRM P1215



PRM P1513



PRM P1515

ITEM NO.	SIZE	EXPANSION	QTY/BOX	QTY/CTN	LB/1,000
PRM P1211	Letter	1¾"	50	200	260
PRM P1213	Letter	3½"	25	100	280
PRM P1215	Letter	5¼"	25	100	320

ITEM NO.	SIZE	EXPANSION	QTY/BOX	QTY/CTN	LB/1,000
PRM P1511	Legal	1¾"	50	200	280
PRM P1513	Legal	3½"	25	100	320
PRM P1515	Legal	5¼"	25	100	360

Custom Colors

We can customize our expandable file pockets with a variety of gussets* and pulp-dyed colors**.

*Custom gussets only available with 1" rolled edge.

**Pulp-dyed colors are 15pt stock and are not textured.



Gusset Color Options



Pulp-Dyed Color Options

Premium End Tab Pockets

LETTER 9½" H x 12½" W, LEGAL 9½" H x 15½" W

Reinforced end tabs make these premium end tab pockets an ideal choice for vertical filing cabinets. The classy outer surface generates a refined look and feel. You'll be more than happy with their quality and striking exterior.

ALL PREMIUM END TAB
POCKETS FEATURE:

- double-ply end tab

- 18pt reinforced manila outside back



PRM ET1211



PRM ET1511



PRM ET1213



PRM ET1215



PRM ET1513



PRM ET1515

ITEM NO.	SIZE	EXPANSION	QTY/ BOX	QTY/ CTN	LB/1,000
PRM ET1211	Letter	1¾"	50	200	260
PRM ET1213	Letter	3½"	25	100	280
PRM ET1215	Letter	5¼"	25	100	320

ITEM NO.	SIZE	EXPANSION	QTY/ BOX	QTY/ CTN	LB/1,000
PRM ET1511	Legal	1¾"	50	200	280
PRM ET1513	Legal	3½"	25	100	320
PRM ET1515	Legal	5¼"	25	100	360



Eyelets



Flexible Side Tabs

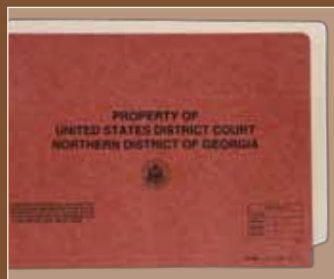

Printed Panels

Custom Features

Attach eyelets for additional gusset stability, request flexible side tabs, or print custom information on any portion of the pocket.

Standard Expandable File Pockets

Standard Pockets

LETTER 9½" H x 11¾" W, LEGAL 9½" H x 14¾" W

Standard pockets are the ideal solution for frequently accessed files and long-term storage. They are resilient and visually appealing, bringing reliability and convenience to your desk. Look no further for quality products at a friendly price.

ALL POCKETS FEATURE:

- 11pt acid-free manila liners

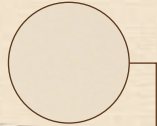

- 11pt Red wallet



- ⅜" rolled edge, 6½" high, Cocoa Swirl Tyvek® gusset



P1211



P1511



P1213



P1215



P1513



P1515

ITEM NO.	SIZE	EXPANSION	QTY/BOX	QTY/CTN	LB/1,000
P1211	Letter	1¾"	50	200	240
P1213	Letter	3½"	25	100	280
P1215	Letter	5¼"	25	100	320

ITEM NO.	SIZE	EXPANSION	QTY/BOX	QTY/CTN	LB/1,000
P1511	Legal	1¾"	50	200	260
P1513	Legal	3½"	25	100	280
P1515	Legal	5¼"	25	100	320

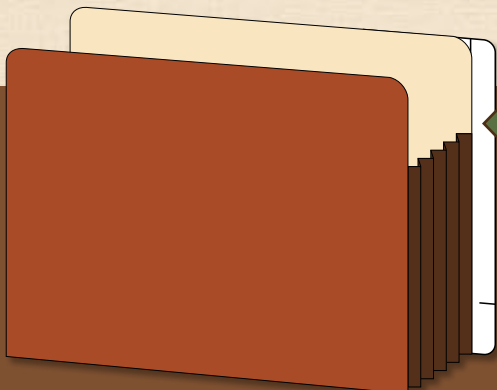

Use an ETC8150 end tab converter with any of our pocket folders (page 22)

Manila file pockets also available (page 16)

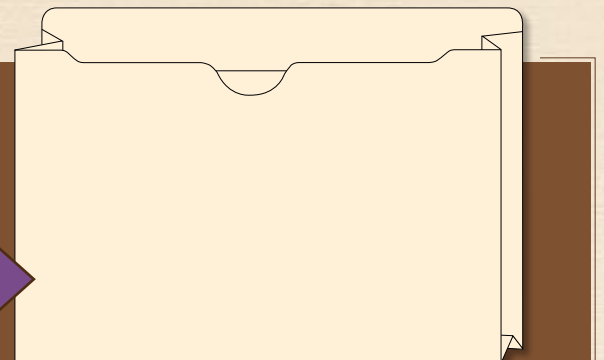

Standard End Tab Pockets

LETTER 9½" H x 12½" W, LEGAL 9½" H x 15½" W

These end tab pockets have all the features of our standard pockets, with sturdy, double-ply end tabs that provide form and function – especially when paired with labels. Your everyday documents will be safe, sound, and quick to find.

ALL END TAB POCKETS FEATURE:

- double-ply end tab



- 11pt reinforced Red wallet outside back



ET1211



ET1511



ET1213



ET1215



ET1513



ET1515

ITEM NO.	SIZE	EXPANSION	QTY/BOX	QTY/CTN	LB/1,000
ET1211	Letter	1¾"	50	200	260
ET1213	Letter	3½"	25	100	280
ET1215	Letter	5¼"	25	100	320

ITEM NO.	SIZE	EXPANSION	QTY/BOX	QTY/CTN	LB/1,000
ET1511	Legal	1¾"	50	200	280
ET1513	Legal	3½"	25	100	320
ET1515	Legal	5¼"	25	100	360



Label Bands

Label and File Pocket handle, in one convenient strip! 48/PKG

YELLOW 9201YL

RED 9202RD

LT BLUE 9203LB

DK BLUE 9204DBL

GREEN 9205GR

WHITE 9206WH

Wallets

10" H x 15" W expansion pocket with full height Tyvek®-reinforced gusset and secure elastic cord. Available in 1¾", 3½", or 5¼" expansion and 11pt or 17pt Red wallet.



- back panel eyelets



- flap is Tyvek®-reinforced

Folders and Pockets

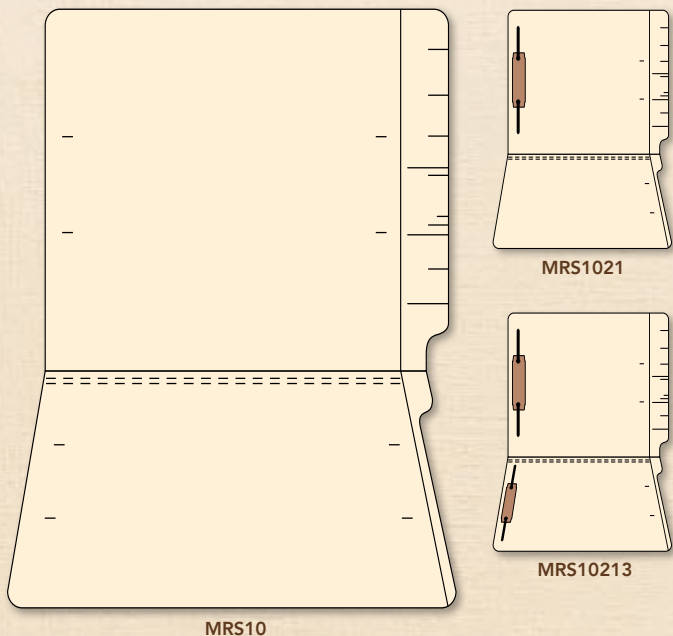

MRS10 & MRS20

Comparable to Tab, Smead, Barkley

- Overall Size: 9½" H x 12¼" W
- Front Size: 9½" H x 11¾" W
- Undercut to: 11⅜"
- Tab Length: 8½"
- Scored for ¾" Expansion
- 10 Scored Tick Marks

ITEM NO.	PAPER WEIGHT	FASTENER POSITION	QTY/BOX	QTY/CTN	LB/1,000
MRS10	11pt	None	100	500	90
MRS1021	11pt	1	50	250	95
MRS10213	11pt	1 & 3	50	250	100
MRS20	14pt	None	50	250	110
MRS2021	14pt	1	50	250	115
MRS20213	14pt	1 & 3	50	250	120
MRSD10*	11pt	None	100	500	90
MRSD1021*	11pt	1	50	250	95
MRSD10213*	11pt	1 & 3	50	250	100

* 9" high front panel

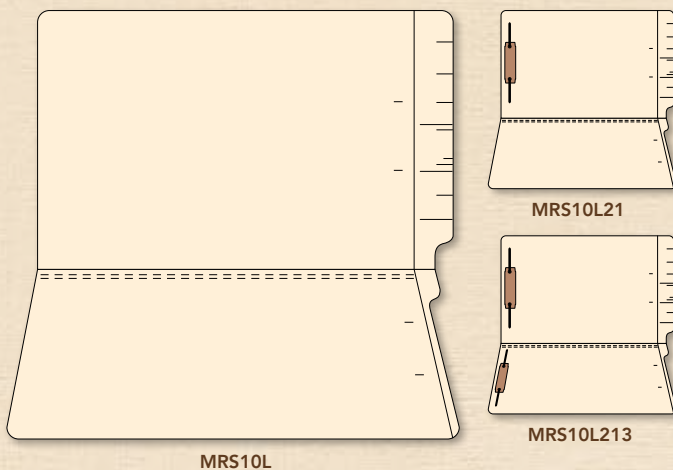

MRS10L & MRS20L

Comparable to Tab, Smead, Barkley

- Overall Size: 9½" H x 15¼" W
- Front Size: 9½" H x 14¾" W
- Undercut to: 14⅜"
- Tab Length: 8½"
- Scored for ¾" Expansion

ITEM NO.	PAPER WEIGHT	FASTENER POSITION	QTY/BOX	QTY/CTN	LB/1,000
MRS10L	11pt	None	100	500	125
MRS10L21	11pt	1	50	250	130
MRS10L213	11pt	1 & 3	50	250	135
MRS20L	14pt	None	50	250	140
MRS20L21	14pt	1	50	250	145
MRS20L213	14pt	1 & 3	50	250	150

Fastener Positions

Fasteners or clips can be ordered in any position. When ordering, state the folder item number, size of fastener, type of fastener, and desired position(s). Refer to these charts for clip and fastener position numbers.

Example: MRS10, 2" fastener, positions 1 and 3

Pay special attention to fastener positions for left-hand tab folders and pocket folders.

Right-Hand Tab Folder

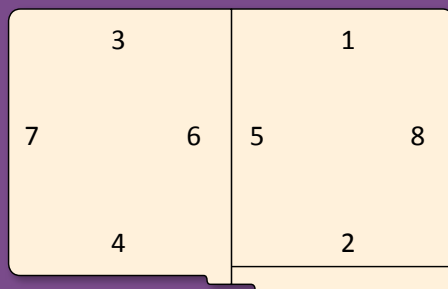

Color-coded labels increase efficiency and organization
(pages 23–30)

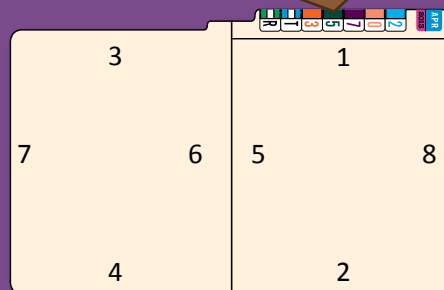

Left-Hand Tab Folder

MW15

**2" W-Fold Expansion Folder
Comparable to Ames**

- Overall Size: 9½" H x 12¼" W
- Front Size: 9½" H x 11⅜" W
- Scored for 2" W-fold Expansion
- Tab Length: 9⅜"
- Interlocking reinforced top and end tab
- Ships bulk packed, flat

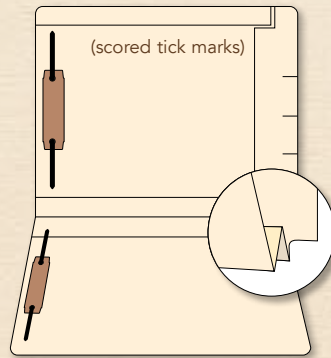

ITEM NO.	PAPER WEIGHT	FASTENER POSITION	QTY/CTN	LB/1,000
MW15	14pt	None	200	95
MW1521	14pt	1	150	100
MW15213	14pt	1 & 3	150	105

MR50

Comparable to Smead, Barkley

- Overall Size: 9½" H x 11¾" W
- Front Size: 8⅞" H x 11¾" W
- Scored for ¾" Expansion
- Tab Length: 11¾"
- Straight Cut reinforced top tab

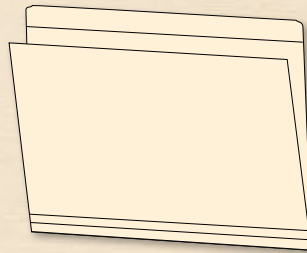

ITEM NO.	PAPER WEIGHT	FASTENER POSITION	QTY/BOX	QTY/CTN	LB/1,000
MR50	11pt	None	100	500	90
MR5021	11pt	1	50	250	95
MR50213	11pt	1 & 3	50	250	100

FP11

11pt Top Tab Pockets

9½" H x 11¾" W overall size. Double-ply tab with double-recessed thumb notch creates more space for labeling and provides easier access to contents. Perfect for drawer filing when quick color references are required. 100/BOX

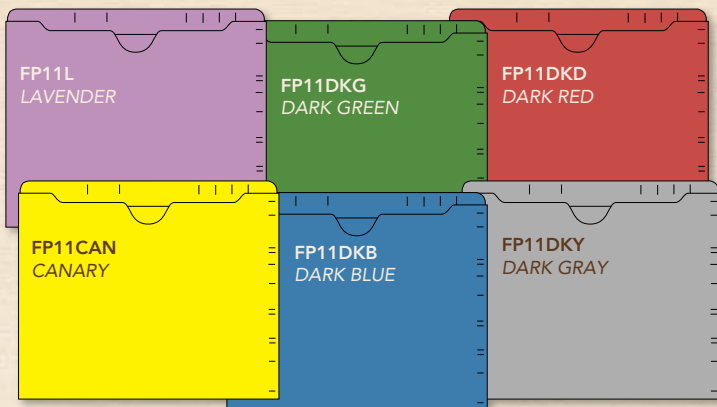

FP11 MANILA (not pictured)

MRS20ETMY

Mylar-Reinforced End Tab

9½" H x 12¼" W double-ply end tab folder. Mylar-reinforced front, back, and end tab is perfect for heavy use.

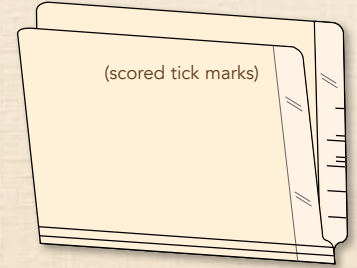

ITEM NO.	PAPER WEIGHT	FASTENER POSITION	QTY/BOX	QTY/CTN	LB/1,000
MRS20ETMY	14pt	None	50	250	110
MRS20ETMY21	14pt	1	50	250	115
MRS20ETMY213	14pt	1 & 3	50	250	120

M9518

Comparable to Smead, Barkley

- Overall Size: 9½" H x 11¾" W
- Front Size: 8⅞" H x 11¾" W
- Scored for ¾" Expansion
- Tab Length: 3¾"
- Packed 1 tab position per box
- Reinforced ⅓ cut top tab; choose L, C, or R position

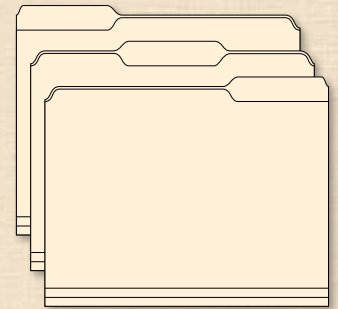

ITEM NO.	PAPER WEIGHT	FASTENER POSITION	QTY/BOX	LB/1,000
M9518 + tab position	11pt	None	100	90
M951821 + tab position	11pt	1	50	95
M9518213 + tab position	11pt	1 & 3	50	100

MXP11

11pt Expansion Pocket

9½" H x 11¾" W overall size, 9" H front. Double-ply top tab with ½" paper gusset expansion. Ships tucked. 50/BOX

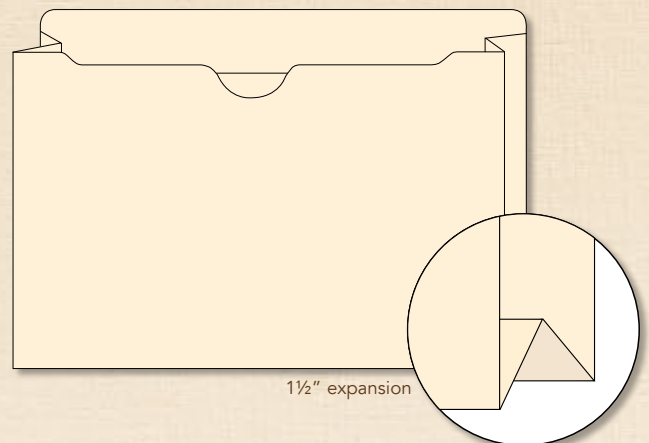

Classification and Presentation Folders

customization... Easy as 1, 2, 3

- 1 Select style and size
(end tab or top tab, letter or legal)
- 2 Choose material (type of pressboard) and color
- 3 Add dividers, fasteners, and more!

Pressboard

Type I: 20pt pulpboard pressed together to create one of the most durable materials in the industry

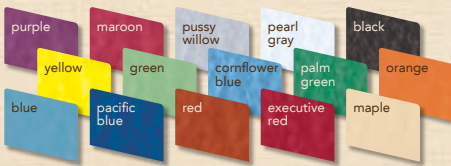

Type II: 25pt medium-density pressboard great for any application



Type III: 25pt pressboard, an all-purpose economical alternative



Tyvek®

Expansions are created with Tyvek®, which is a strong, virtually tear-proof material. The most common colors are New Brown and Dove Grey, stocked in many popular sizes. Twenty-two additional colors are available upon request when purchased in minimum quantities.



Tyvek® is a trademark or registered trademark of E.I. du Pont de Nemours and Company.



custom presentation folders... **Enhanced Brand Identity**

Your firm will stand out when you display a polished, consistent image with custom presentation solutions. Brand integrity is important, and you will build your presence in the community when you present legal documents to your clients using quality presentation materials. We've got you covered from portfolios to folders, paper colors to foil-stamped printing, plus optional business card diecuts in the pockets.



Paper Choices Include:

black linen	emerald green linen	burgundy linen
natural linen	midnight blue linen	evergreen felt
navy felt	merlot felt	soft white felt

**Call us and ask about more
paper and foil options!**

Binders and Report Covers

Sturdy pressboard binders and report covers available in multiple colors and sizes.

- 2" fastener included
- Tyvek® reinforcement strengthens spine edges
- Choose from all pressboard types (*page 17*)
- Letter or legal
- Side or top binding



Patent and Trademark **Application Folders**

Application Folders

14½" H x 10" W

The tri-fold design of these patent and trademark folders keeps documents organized, secure, and easily accessible throughout the entire trademark process. Our folders are durable and designed to last.

ALL PATENT AND TRADEMARK FOLDERS FEATURE: • 15pt acid-free paper

• Scoring for ½" expansion

• Top flaps hole-punched for fasteners

PAT120 BACK



PAT120

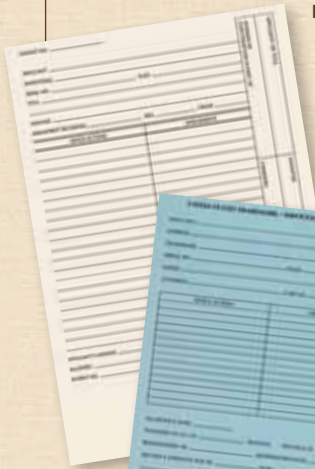

PAT122

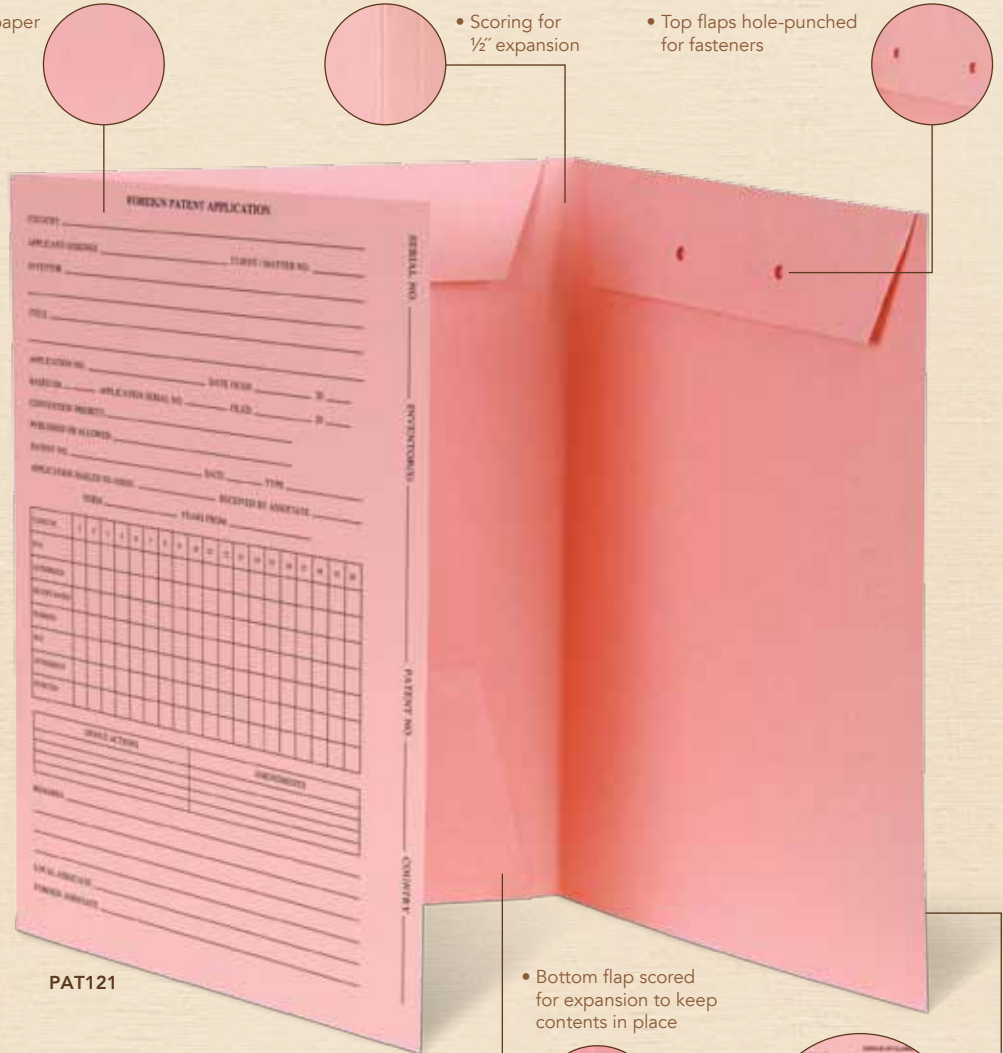
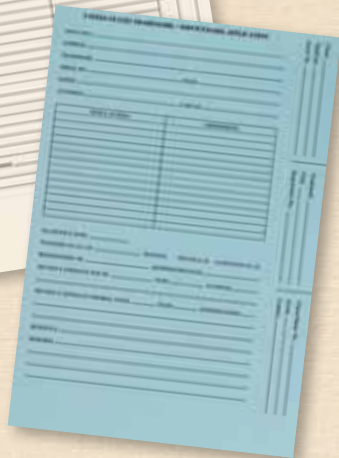

PAT121

• Bottom flap scored for expansion to keep contents in place

ITEM NO.	DESCRIPTION	QTY/BOX	QTY/CTN	LB/1,000
PAT120	Manila - Patent Application	25	100	240
PAT121	Salmon - Foreign Trade Application	25	100	240
PAT122	Blue - US Trade/Service Mark Application	25	100	240

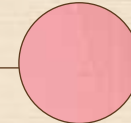

PAT121 BACK

Custom Options

15pt Colors



20pt Colors



- End tab configuration
- Custom printing on any panel
- Fasteners installed
- Hole-punching
- Elastic or VELCRO® closure
- Reinforced or flexible end tabs
- Tyvek® gussets
- Store digital media with our 2GB or 4GB DigiStrip (page 21)

VELCRO® is a registered trademark of Velcro Industries B.V.

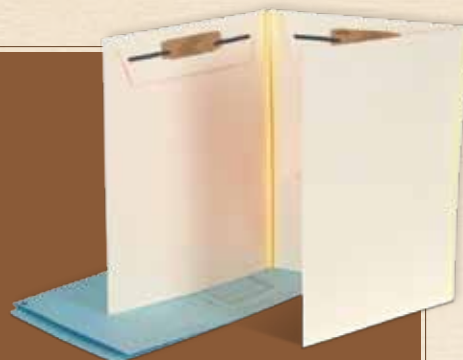

We can customize a folder to match nearly any style or design. Let our experts find the perfect solution to meet your needs.

simplyfile

mailing and filing: simplified

i'm an envelope!

Introducing the all-new Simplyfile! It starts out flat, for the sender to fill with organized information, securely attached to an installed fastener (optional). Then it is folded and sealed, transforming it into an envelope! Once it's delivered...

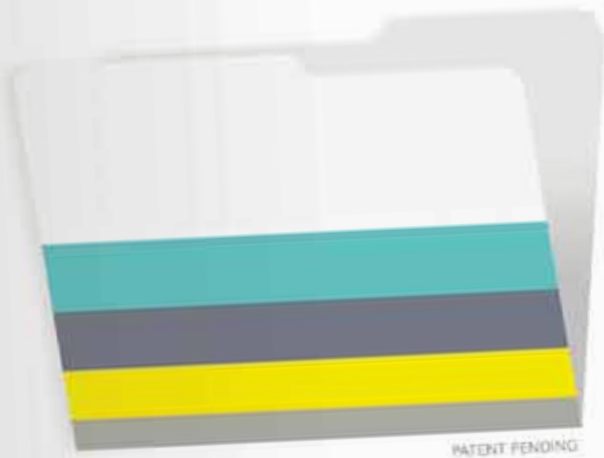

now i'm a folder!

...the recipient tears along the perforations and files the folder, documents and all. It's two products in one, making it a great, cost-effective way to share and retain important information. The Simplyfile makes sending and receiving documents simple!

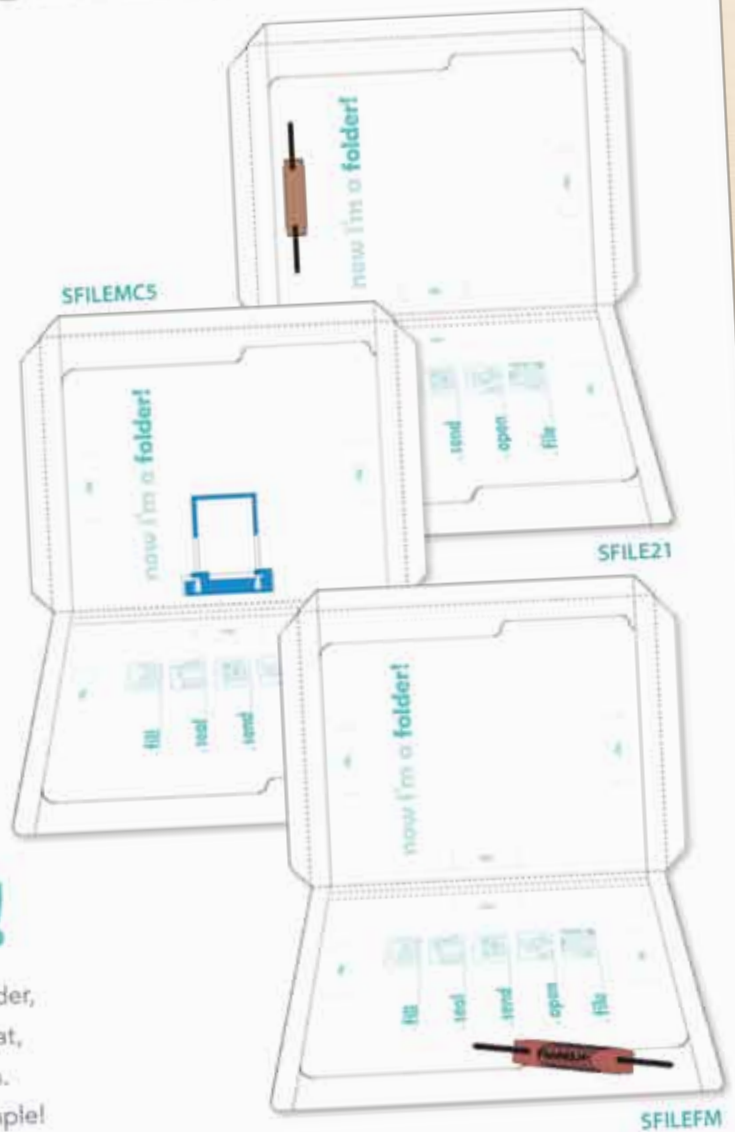

ITEM NO.	DESCRIPTION	QTY/ PKG	LB/ PKG
SFILE	9½" H x 11¾" W, ¾" expansion, no fastener included	10	1½
SFILE21	9½" H x 11¾" W, ¾" expansion, bonded 2" fastener in position 1	10	2
SFILEFM	9½" H x 11¾" W, ¾" expansion, 10 loose 2914 Foam Clips included	10	2
SFILEMCS	9½" H x 11¾" W, ¾" expansion, Docu-Clip in position 5	10	2½

Customize it!

If you need different fasteners or want to brand the Simplyfile with your own artwork, we can help. Call us today for a quote!



fill



seal



send



open



file

Fasteners and Accessories

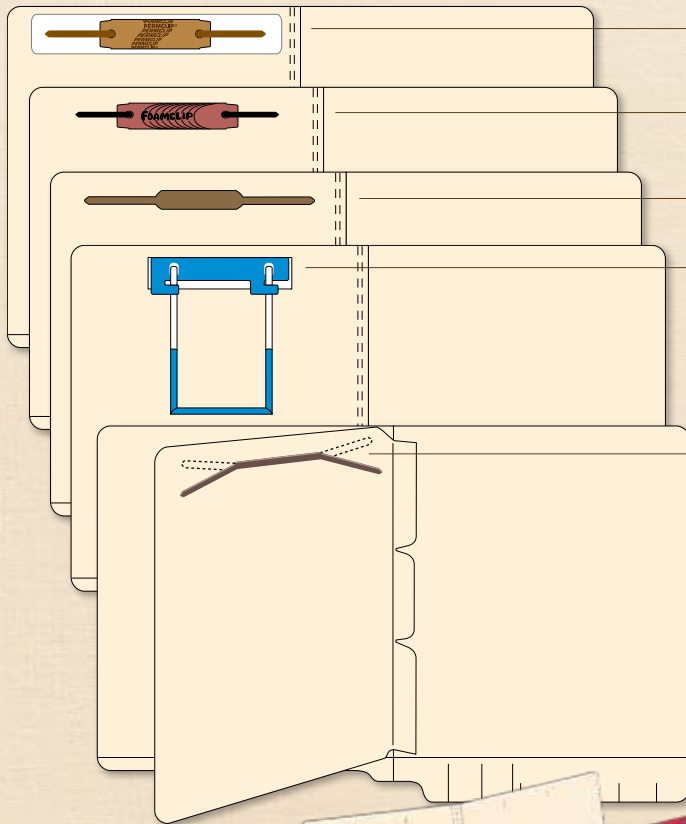

Self-Adhesive Sem-Clip (2912)
2" capacity bonded fastener on self-adhesive label backing. Easy to position and apply. 100/PKG

Foam Clip (2914)
1½" capacity foam clip fastener designed for heavy-duty use with an extra-strong adhesive foam backer. 100/BOX

MediClip / DocuClip (2913)
Unique 5" capacity fastener converts any file folder into a loose-leaf ring binder. Flexible 3-piece construction attaches to any type of file folder. 100/BOX

1ABF or 2ABF
Self-adhesive metal fastener with two methods of application, available in 1" or 2" capacity. Insert prongs through die-cut slits from outside of folder for bulky records, or mount inside with adhesive base. Easy-to-use location template included. 100/BOX

2915 (TP1L)
Insert prongs through slits in the divider (like our self-adhesive divider), then fold back one side of the prong to make a secure fastener for both sides. Positioned this way it will have a 1" capacity on one side and ½" on the other. 100/BOX

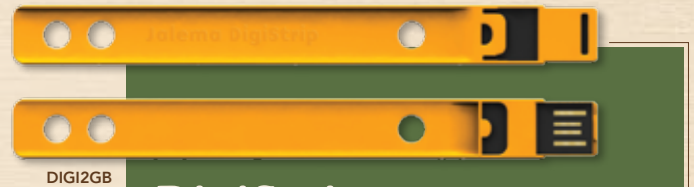

DigiStrip

The DigiStrip is a USB flash drive fastener attachment that stores all corresponding digital files with the physical records.

- Perfect for presentations, images, or video
- No more lost USB flash drives
- Available in either 2GB or 4GB capacity

Pockets

Self-adhesive. 100/PKG

- 7250S** 5 Mil Poly, 9¼" x 6"
- VP85SA** 6 Mil Vinyl, 9" x 5½"
- LP610SA** Lock-It Poly, 6½" W x 10" H
- LP565A** Lock-It Poly, 5½" W x 6¼" H



Conversion Flaps (CONVFLAP)

Convert standard indexes into fileback dividers. Works with any fastener with 2¾" center-to-center holes. 50/BOX



U-File-M (U-FILE-M)

Make each folder read like a book. Records are affixed to tabs of strip in either ascending or descending order, with either oldest or newest information on the top. 100/BOX



MediStrip (DOCUSET)

Adding a MediStrip saves additional space by doing away with the compressor and allows for easier viewing, insertion or deletion of material. It allows file dividers and pages to turn easily and lie flat, similar to a ring binder. You can easily add and remove pages by separating the extension piece and the tube base. 100/PKG



Reinforcing Strips (7551RS)

Add durability to important documents that are mounted within charts, or repair any ripped 2-hole punches. Pre-punched strips are clear, self-adhesive, 3⅝" W x 1" H. Holes are ¼" diameter and spaced 2¾" apart center-to-center. 500/BOX

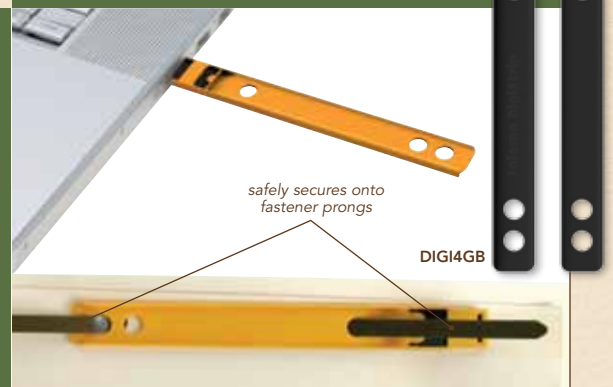

Bottom Tab Outguides

Body 9½" x 11⅞", Overall 9½" x 13"

Angle cut pocket and thumb-notched charge-out slip pocket. Double-sided "OUT" tab on bottom.

ITEM NO.	COLOR
OG4800CL	Clear
OG4801BE	Blue
OG4803LBE	Light Blue
OG4807G	Green
OG4808L	Lavender
OG4810BK	Black
OG4811OR	Orange
OG4812PK	Pink
OG4813P	Purple
OG4814R	Red
OG4817Y	Yellow



ITEM NO.	COLOR
OG8801BE	Blue
OG8807GN	Green
OG8808LV	Lavender
OG8811OR	Orange
OG8812PK	Pink
OG8814R	Red
OG8817Y	Yellow



Angle cut pocket with lower angle cut charge-out slip pocket. Triple thickness single-sided "OUT" tab on bottom.

ITEM NO.	COLOR
OG5800CL	Clear
OG5801BE	Blue
OG5803LBE	Light Blue
OG5807G	Green
OG5808L	Lavender
OG5810BK	Black
OG5811OR	Orange
OG5812PK	Pink
OG5813P	Purple
OG5814R	Red
OG5817Y	Yellow

Center Tab Outguides

Body 9½" x 11⅞", Overall 9½" x 12⅞"

Angle cut pocket with top charge-out slip pocket. Center placed double-sided "OUT" tab.

ITEM NO.	COLOR
OG7801BE	Blue
OG7803LBE	Light Blue
OG7807GN	Green
OG7808L	Lavender
OG7810BK	Black
OG7811OR	Orange
OG7812PK	Pink
OG7813P	Purple
OG7814R	Red
OG7817Y	Yellow



Charge-Out Slips

These simple forms provide written records to control borrowed files. Slips are inserted into the smaller pockets of outguides. 100/PKG

FILE NAME: NUMBER	_____
DATE	_____
DATE TO BE RETURNED	_____
REMOVED BY	_____
REMARKS:	_____
<small>WHEN REMOVING A FOLDER FROM THE FILE, PLEASE ENTER FOLDER NUMBER AND I OR II, IF APPLICABLE, ON YOUR MARK. MARKS DATE REMOVED DATE TO BE RETURNED AND FOLDER NUMBER AND THE PROJECT OF THE OUT SLIP. REPORT OUT CHARGE IN PLACE OF FOLDER NUMBER.</small>	
<small>FORM NO. 7800-1 (REV. 10/11)</small>	<small>Copyright © 2011</small>

7800CO

End Tab Converters

End Tab Converters are quick and economical alternatives to replacing entire file folders. Self-adhesive strips adhere to both the front and back of the folder, or a large panel of adhesive adheres to the back.

ITEM NO.	COLOR	SIZE
ETC9165	White	Full End Tab
ETC9150	White	8" End Tab
ETC9150M	Manila	8" End Tab
ETC8150	White	Full End Tab

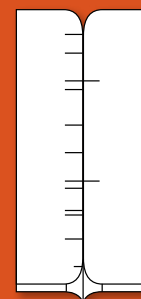

ETC9165
500/PKG



ETC9150
500/PKG

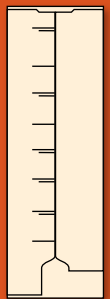

ETC9150M
500/PKG



ETC8150
100/PKG

Alphabetic Labels

2400 Series

Barkley® ABKM & SYCOM® Compatible,
1" H x 1½" W (Poly laminated)



MAP-Pack 24M05F
Pack 2405F
Roll 2465F



MAP-Pack 24M06G
Pack 2406G
Roll 2466G



MAP-Pack 24M07H
Pack 2407H
Roll 2467H

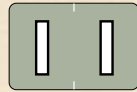

MAP-Pack 24M08I
Pack 2408I
Roll 2468I

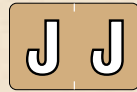

MAP-Pack 24M09J
Pack 2409J
Roll 2469J



MAP-Pack 24M10K
Pack 2410K
Roll 2470K



MAP-Pack 24M11L
Pack 2411L
Roll 2471L



MAP-Pack 24M12M
Pack 2412M
Roll 2472M



MAP-Pack 24M13N
Pack 2413N
Roll 2473N

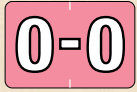

MAP-Pack 24M14O
Pack 2414O
Roll 2474O



MAP-Pack 24M15P
Pack 2415P
Roll 2475P



MAP-Pack 24M16Q
Pack 2416Q
Roll 2476Q



MAP-Pack 24M17R
Pack 2417R
Roll 2477R



MAP-Pack 24M18S
Pack 2418S
Roll 2478S



MAP-Pack 24M19T
Pack 2419T
Roll 2479T



MAP-Pack 24M20U
Pack 2420U
Roll 2480U

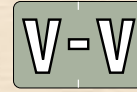

MAP-Pack 24M21V
Pack 2421V
Roll 2481V



MAP-Pack 24M22W
Pack 2422W
Roll 2482W



MAP-Pack 24M23X
Pack 2423X
Roll 2483X



MAP-Pack 24M24Y
Pack 2424Y
Roll 2484Y



MAP-Pack 24M25Z
Pack 2425Z
Roll 2485Z



MAP-Pack 24M26Mc
Pack 2426Mc
Roll 2486Mc

MAP-PACK 9 labels/sheet, 126 labels

PACK 9 labels/sheet, 225 labels

ROLL 500 labels

Complete Roll Set 2489SET
27 rolls, display unit, 13,500 labels

Complete Set 2429SET

27 packs/6,075 labels

Starter Kit 2427SK

File box, Indexes, 2,016 assorted labels

Refill Kit 2428RK

2,016 assorted labels

1200 Series

Smead® BCCR/BCCS Compatible,
1" H x 1¼" W (Poly laminated)



MAP-Pack 12M07H
Pack 1207H
Roll 1267H



MAP-Pack 12M08I
Pack 1208I
Roll 1268I



MAP-Pack 12M09J
Pack 1209J
Roll 1269J



MAP-Pack 12M10K
Pack 1210K
Roll 1270K



MAP-Pack 12M11L
Pack 1211L
Roll 1271L



MAP-Pack 12M12M
Pack 1212M
Roll 1272M

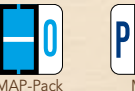

MAP-Pack 12M13N
Pack 1213N
Roll 1273N

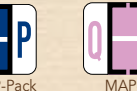

MAP-Pack 12M14O
Pack 1214O
Roll 1274O



MAP-Pack 12M15P
Pack 1215P
Roll 1275P



MAP-Pack 12M18S
Pack 1218S
Roll 1278S



MAP-Pack 12M19T
Pack 1219T
Roll 1279T



MAP-Pack 12M20U
Pack 1220U
Roll 1280U



MAP-Pack 12M21V
Pack 1221V
Roll 1281V



MAP-Pack 12M22W
Pack 1222W
Roll 1282W



MAP-Pack 12M23X
Pack 1223X
Roll 1283X



MAP-Pack 12M24Y
Pack 1224Y
Roll 1284Y



MAP-Pack 12M25Z
Pack 1225Z
Roll 1285Z

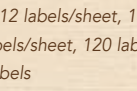

MAP-Pack 12M26Mc
Pack 1226Mc
Roll 1286Mc

MAP-PACK 12 labels/sheet, 132 labels

PACK 12 labels/sheet, 120 labels

ROLL 500 labels

Complete Roll Set 1289SET
27 rolls, display unit, 13,500 labels

Complete Set 1229SET

27 packs/3,240 labels

Starter Kit 1227SK

File box, Indexes, 2,484 assorted labels

Refill Kit 1228RK

2,484 assorted labels

1300 Series

JETER® 7200, 7100 & 5800 Compatible,
1½" H x 1½" W (Poly laminated)



MAP-Pack 13M00A
Pack 1300A
Ringbook 1330A
Roll 1360A



MAP-Pack 13M01B
Pack 1301B
Ringbook 1331B
Roll 1361B



MAP-Pack 13M02C
Pack 1302C
Ringbook 1332C
Roll 1362C



MAP-Pack 13M03D
Pack 1303D
Ringbook 1333D
Roll 1363D



MAP-Pack 13M04E
Pack 1304E
Ringbook 1334E
Roll 1364E



MAP-Pack 13M05F
Pack 1305F
Ringbook 1335F
Roll 1365F



MAP-Pack 13M06G
Pack 1306G
Ringbook 1336G
Roll 1366G



MAP-Pack 13M07H
Pack 1307H
Ringbook 1337H
Roll 1367H



MAP-Pack 13M08I
Pack 1308I
Ringbook 1338I
Roll 1368I



MAP-Pack 13M09J
Pack 1309J
Ringbook 1339J
Roll 1369J



MAP-Pack 13M10K
Pack 1310K
Ringbook 1340K
Roll 1370K



MAP-Pack 13M11L
Pack 1311L
Ringbook 1341L
Roll 1371L



MAP-Pack 13M12M
Pack 1312M
Ringbook 1342M
Roll 1372M



MAP-Pack 13M13N
Pack 1313N
Ringbook 1343N
Roll 1373N

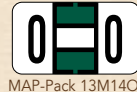

MAP-Pack 13M14O
Pack 1314O
Ringbook 1344O
Roll 1374O



MAP-Pack 13M15P
Pack 1315P
Ringbook 1345P
Roll 1375P



MAP-Pack 13M16Q
Pack 1316Q
Ringbook 1346Q
Roll 1376Q



MAP-Pack 13M17R
Pack 1317R
Ringbook 1347R
Roll 1377R



MAP-Pack 13M18S
Pack 1318S
Ringbook 1348S
Roll 1378S



MAP-Pack 13M19T
Pack 1319T
Ringbook 1349T
Roll 1379T



MAP-Pack 13M20U
Pack 1320U
Ringbook 1350U
Roll 1380U



MAP-Pack 13M21V
Pack 1321V
Ringbook 1351V
Roll 1381V



MAP-Pack 13M22W
Pack 1322W
Ringbook 1352W
Roll 1382W



MAP-Pack 13M23X
Pack 1323X
Ringbook 1353X
Roll 1383X



MAP-Pack 13M24Y
Pack 1324Y
Ringbook 1354Y
Roll 1384Y



MAP-Pack 13M25Z
Pack 1325Z
Ringbook 1355Z
Roll 1385Z



MAP-Pack 13M26Mc
Pack 1326Mc
Ringbook 1356Mc
Roll 1386Mc

MAP-PACK 9 labels/sheet, 126 labels

PACK 9 labels/sheet, 225 labels

RINGBOOK 24 labels/sheet, 240 labels

ROLL 500 labels

Complete Roll Set 1389SET

27 rolls, display unit, 13,500 labels

Complete Ringbook Set 1359SET

27 packs/6,480 labels

Ringbook Starter Kit 1357SK

Binder, Indexes, 3,471 assorted labels

Ringbook Refill Kit 1358RK

3,120 assorted labels

Complete Set 1329SET

27 packs/6,075 labels

Starter Kit 1327SK

File box, Indexes, 2,898 assorted labels

Refill Kit 1328RK 2,898 assorted labels

8600 Series

Colwell Jewel Tone Compatible
1" H x 1½" W (Poly laminated)



MAP-Pack 86M00A
Pack 8600A
Ringbook 8630A
Roll 8660A



MAP-Pack 86M01B
Pack 8601B
Ringbook 8631B
Roll 8661B



MAP-Pack 86M02C
Pack 8602C
Ringbook 8632C
Roll 8662C



MAP-Pack 86M03D
Pack 8603D
Ringbook 8633D
Roll 8663D



MAP-Pack 86M04E
Pack 8604E
Ringbook 8634E
Roll 8664E



MAP-Pack 86M05F
Pack 8605F
Ringbook 8635F
Roll 8665F



MAP-Pack 86M06G
Pack 8606G
Ringbook 8636G
Roll 8666G



MAP-Pack 86M07H
Pack 8607H
Ringbook 8637H
Roll 8667H



MAP-Pack 86M08I
Pack 8608I
Ringbook 8638I
Roll 8668I

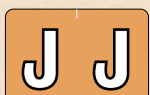

MAP-Pack 86M09J
Pack 8609J
Ringbook 8639J
Roll 8669J



MAP-Pack 86M10K
Pack 8610K
Ringbook 8640K
Roll 8670K



MAP-Pack 86M11L
Pack 8611L
Ringbook 8641L
Roll 8671L



MAP-Pack 86M12M
Pack 8612M
Ringbook 8642M
Roll 8672M



MAP-Pack 86M13N
Pack 8613N
Ringbook 8643N
Roll 8673N



MAP-Pack 86M14O
Pack 8614O
Ringbook 8644O
Roll 8674O



MAP-Pack 86M15P
Pack 8615P
Ringbook 8645P
Roll 8675P

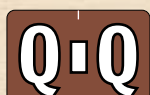

MAP-Pack 86M16Q
Pack 8616Q
Ringbook 8646Q
Roll 8676Q



MAP-Pack 86M17R
Pack 8617R
Ringbook 8647R
Roll 8677R



MAP-Pack 86M18S
Pack 8618S
Ringbook 8648S
Roll 8678S



MAP-Pack 86M19T
Pack 8619T
Ringbook 8649T
Roll 8679T

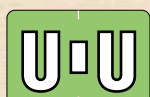

MAP-Pack 86M20U
Pack 8620U
Ringbook 8650U
Roll 8680U



MAP-Pack 86M21V
Pack 8621V
Ringbook 8651V
Roll 8681V



MAP-Pack 86M22W
Pack 8622W
Ringbook 8652W
Roll 8682W



MAP-Pack 86M23X
Pack 8623X
Ringbook 8653X
Roll 8683X



MAP-Pack 86M24Y
Pack 8624Y
Ringbook 8654Y
Roll 8684Y



MAP-Pack 86M25Z
Pack 8625Z
Ringbook 8655Z
Roll 8685Z



MAP-Pack 86M26Mc
Pack 8626Mc
Ringbook 8656Mc
Roll 8686Mc

MAP-PACK 9 labels/sheet, 126 labels

PACK 9 labels/sheet, 225 labels

ROLL 500 labels

Complete Roll Set 8689SET

27 rolls, display unit, 13,500 labels

Starter Kit 8627SK

File box, Indexes, 2,898 assorted labels

Ringbook Starter Kit 8657SK

Binder, Indexes, 3,144 assorted labels

1000 Series

TAB® 1283/1286 Compatible
1" H x 1¼" W (Vinyl)



Pack 1000A
Ringbook 1030A
Roll 1060A



Pack 1001B
Ringbook 1031B
Roll 1061B



Pack 1002C
Ringbook 1032C
Roll 1062C



Pack 1003D
Ringbook 1033D
Roll 1063D



Pack 1004E
Ringbook 1034E
Roll 1064E



Pack 1005F
Ringbook 1035F
Roll 1065F



Pack 1006G
Ringbook 1036G
Roll 1066G



Pack 1007H
Ringbook 1037H
Roll 1067H



Pack 1008I
Ringbook 1038I
Roll 1068I



Pack 1009J
Ringbook 1039J
Roll 1069J



Pack 1010K
Ringbook 1040K
Roll 1070K



Pack 1011L
Ringbook 1041L
Roll 1071L



Pack 1012M
Ringbook 1042M
Roll 1072M



Pack 1013N
Ringbook 1043N
Roll 1073N



Pack 1014O
Ringbook 1044O
Roll 1074O



Pack 1015P
Ringbook 1045P
Roll 1075P



Pack 1016Q
Ringbook 1046Q
Roll 1076Q



Pack 1017R
Ringbook 1047R
Roll 1077R



Pack 1018S
Ringbook 1048S
Roll 1078S



Pack 1019T
Ringbook 1049T
Roll 1079T



Pack 1020U
Ringbook 1050U
Roll 1080U



Pack 1021V
Ringbook 1051V
Roll 1081V



Pack 1022W
Ringbook 1052W
Roll 1082W



Pack 1023X
Ringbook 1053X
Roll 1083X



Pack 1024Y
Ringbook 1054Y
Roll 1084Y



Pack 1025Z
Ringbook 1055Z
Roll 1085Z



Pack 1026Mc
Ringbook 1056Mc
Roll 1086Mc

PACK 9 labels/sheet, 225 labels

RINGBOOK 50 labels/sheet, 500 labels

ROLL 500 labels

Complete Roll Set 1089SET

27 rolls, display unit, 13,500 labels

Starter Kit 1027SK

File box, Indexes, 2,898 assorted labels

Complete Ringbook Set 1059SET

27 packs/13,500 labels

Ringbook Starter Kit 1057SK

Binder, Indexes, 3,200 assorted labels

Ringbook Refill Kit 1058RK

3,200 assorted labels

Complete Set 1029SET

27 packs/6,075 labels

Starter Kit 1027SK

File box, Indexes, 2,898 assorted labels

Refill Kit 1028RK

2,898 assorted labels

Numeric and Solid Color Labels

4000 Series

TAB® 1382 Compatible
1" H x 1¼" W (Vinyl)



8300 Series

Colwell Jewel Tone Compatible
1" H x 1½" W (Polylaminated)



5000 Series

GBS® (VRE) 8860 Compatible
1½" H x 1¼" W (Polylaminated)



4800 Series

JETER® 6100 Compatible
1½" H x 1⅝" W (Polylaminated)



6000 Series

JETER® 9500/5300 Compatible
¾" H x 1½" W (Polylaminated)

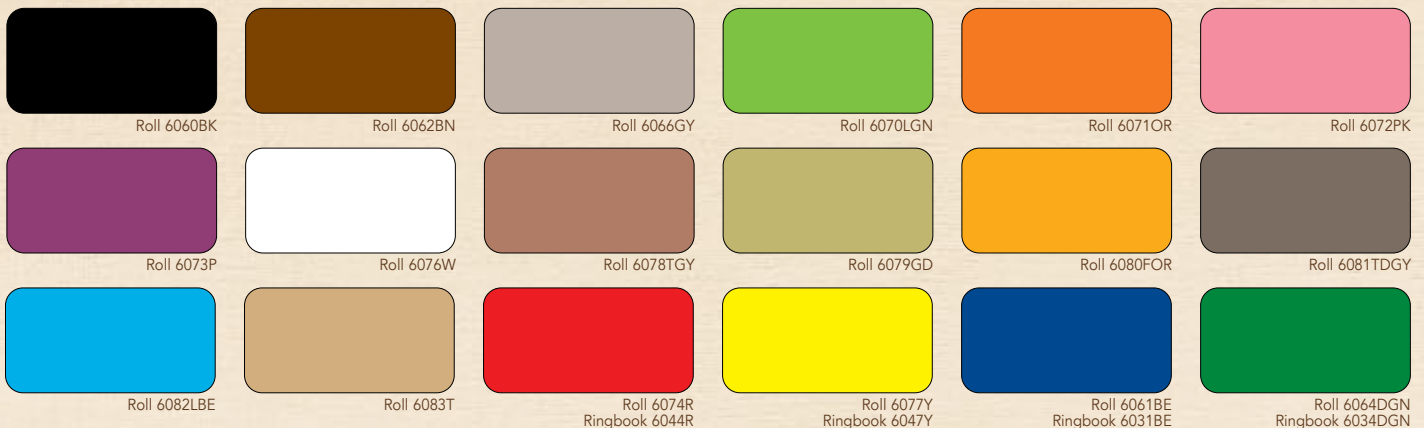
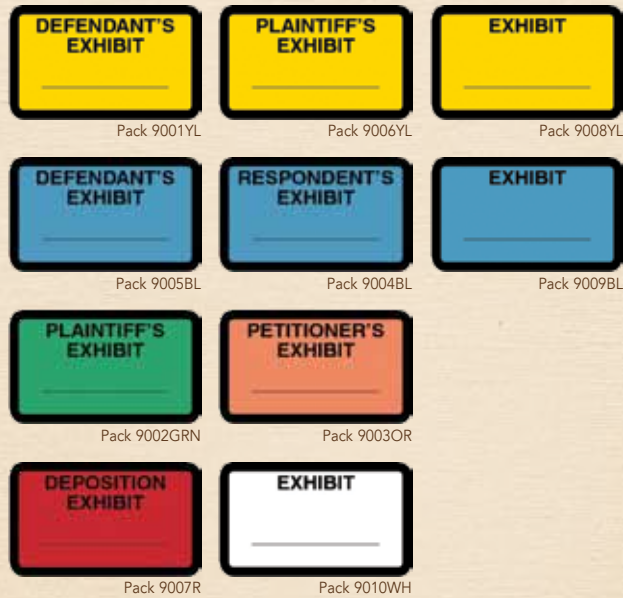

Exhibit and Year Labels

Exhibit Labels

Color-coded for quick identification,
space for writing letters or numbers

1" H x 1 5/8" W (9 labels/sheet, 252 labels/pack)



Print-On Exhibit Labels

Blank exhibit labels for laser printing,
instructions in each package

1" H x 1 5/8" W (20 labels/sheet, 240 labels/pack)

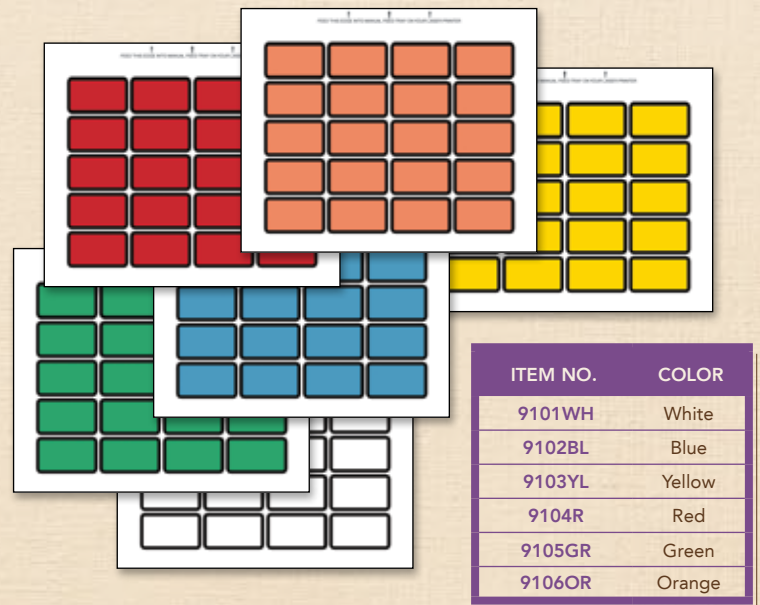

11000 Series 2012

Jeter Compatible

1 5/16" H x 1 5/8" W (Polylaminated)



PACKAGE 225 labels

Complete Set 11229SET 2,700 labels

Complete Mini Set 11229MSET 216 labels

11000 Series 2013

Jeter Compatible

1 5/16" H x 1 5/8" W (Polylaminated)

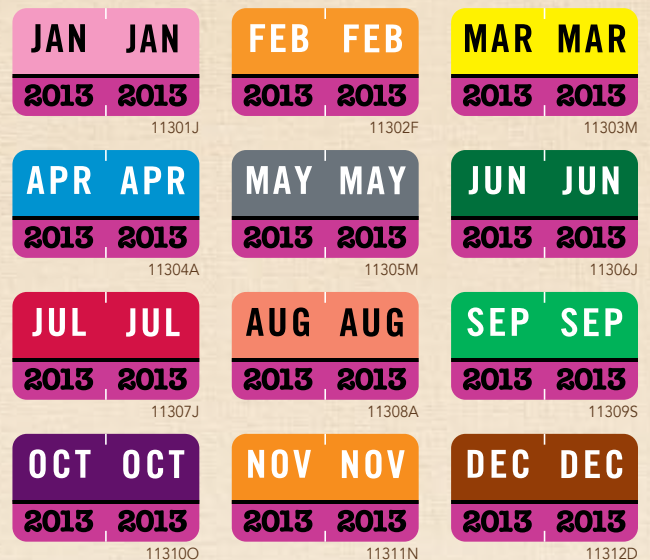

PACKAGE 225 labels

Complete Set 11329SET 2,700 labels

Complete Mini Set 11329MSET 216 labels

Year and Month Labels



2013 0713FLGN
2012 0712FLGN

PMA FLUORESCENT
1½" W x ¾" H
(Polylaminated) 500/Roll



2013 0713FLPK
2012 0712FLPK



2013 0713FLY
2012 0712FLY



2013 0713FLOR
2012 0712FLOR



2013 0713FLRD
2012 0712FLRD

BEST TAB
1½" W x ¾" H
(Polylaminated) 500/Roll



2013 0713GNY
2012 0712GNY



2013 0713BEY
2012 0712BEY



2013 0713ORY
2012 0712ORY



2013 0713RY
2012 0712RY

PMA HOLOGRAPHIC
1½" W x ¾" H
(Polylaminated) 500/Roll



2013 0713HBE
2012 0712HBE



2013 0713HOR
2012 0712HOR



2013 0713HAQ
2012 0712HAQ



2013 0713HGN
2012 0712HGN



2013 0713HV
2012 0712HV



2013 0713HRD
2012 0712HRD

Amerfile 1½" W x ¾" H
(Polylaminated) 500/Roll



2013 0713GRN
2012 0712FUS

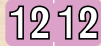

Safeguard 1½" W x ¾" H
(Polylaminated) 500/Roll



2013 0713LV
2012 0712LBE



Patterson/Colwell 1½" W x ¾" H
(Polylaminated) 500/Roll



2013 0713BNJTE
2012 0712GJTE



POS 1½" W x ¾" H
(Polylaminated) 500/Roll



2013 0713POS
2012 0712POS

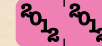

Reynolds & Reynolds 1½" W x ¾" H
(Polylaminated) 500/Roll

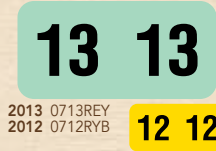

2013 0713REY
2012 0712RYB



Barkley 1½" W x ¾" H
(Polylaminated) 500/Roll



2013 0713OR
2012 0712YE

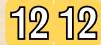

Col'R'Tab 1½" W x ¾" H
(Polylaminated) 500/Roll



2013 0713LGN
2012 0712RD



Patterson/Colwell ¾" W x 1½" H
(Polylaminated) 500/Roll



2013 0713BNJTT
2012 0712GJTT



POS 1½" W x ¾" H
(Polylaminated) 500/Roll



2013 0713RD
2012 0712GLD



Smead/Jeter 1½" W x ¾" H
(Polylaminated) 500/Roll

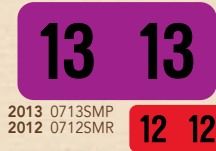

2013 0713SMP
2012 0712SMR



Jeter 1½" W x ¾" H
(Polylaminated) 500/Roll



2013 0713JP
2012 0712JRD



Control-O-Fax 1½" W x ¾" H
(Vinyl) 500/Roll



2013 0713COF
2012 0712COF



Patterson/Colwell 1" W x ½" H
(Polylaminated) 500/RB Pkg



2013 0213BNJTE
2012 0212GJTE

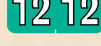

POS 1½" W x ¾" H
(Vinyl) 500/Roll



2013 0713PWH
2012 0712RDY



Smead 1" W x ½" H
(Polylaminated) 500/Roll

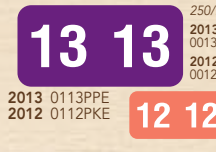

2013 0113PPE
2012 0112PKE



Jeter - R Series 1½" W x ¾" H
(Polylaminated) 500/Roll

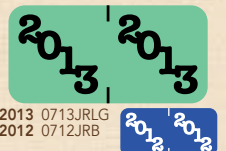

2013 0713JRLG
2012 0712JRB



GBS/VRE 1½" W x ¾" H
(Polylaminated) 500/Roll



2013 0713PUR
2012 0712PK



Patterson/Colwell ½" W x 1" H
(Polylaminated) 500/RB Pkg



2013 0213BNJTT
2012 0212GJTT



POS 1½" W x ½" H
(Vinyl) 500/Roll



2013 0613PWH
2012 0612RDY



Smead ½" W x 1" H
(Polylaminated) 500/Roll

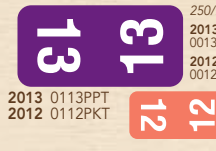

2013 0113PPT
2012 0112PKT



Jeter Proprietary 1½" W x ¾" H
(Polylaminated) 500/Roll

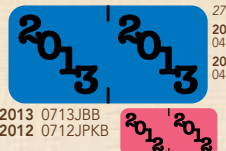

2013 0713JBB
2012 0712JPKB

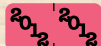

Traco 1½" W x ¾" H
(Polylaminated) 500/Roll

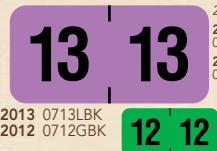

2013 0713LBK
2012 0712GBK



TAB 1¼" W x ¾" H
(Vinyl) 500/Roll



2013 0713DOR
2012 0712LOR



Ames 1½" W x 1½" H
(Semi-Gloss) 1,000/Roll



2013 0813AMOR
2012 0812AMBE



Traco 1" W x ½" H
(Polylaminated) 500/Roll

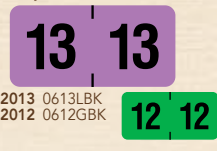

2013 0613LBK
2012 0612GBK



TAB 1½" W x ½" H
(Vinyl) 500/Roll



2013 0613DOR
2012 0612LOR



Ames 1¾" W x ½" H
(Semi-Gloss) 1,000/Roll



2013 0613AMOR
2012 0612AMBE



16100 Series

Barkley® MBLM Compatible
 $\frac{3}{4}$ " H x $1\frac{1}{2}$ " W (Polylaminated)

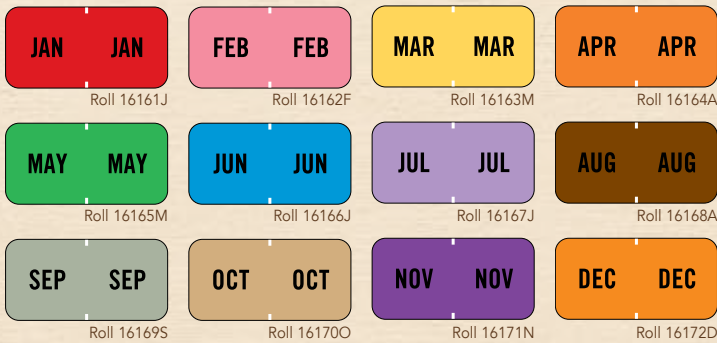

18000 Series

JETER® 7000 Compatible
 $1\frac{5}{16}$ " H x $1\frac{5}{8}$ " W (Polylaminated)



15000 Series

Reynolds & Reynolds® RF Compatible
 $\frac{3}{4}$ " H x $1\frac{1}{2}$ " W (Polylaminated)

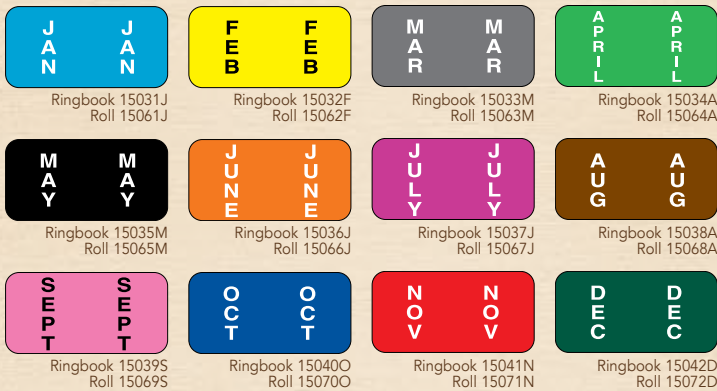

16000 Series

Smead® ETS Compatible
 $\frac{1}{2}$ " H x 1" W (Polylaminated)



17000 Series

Sycom® 5918 Compatible
 $\frac{3}{4}$ " H x $1\frac{1}{2}$ " W (Polylaminated)

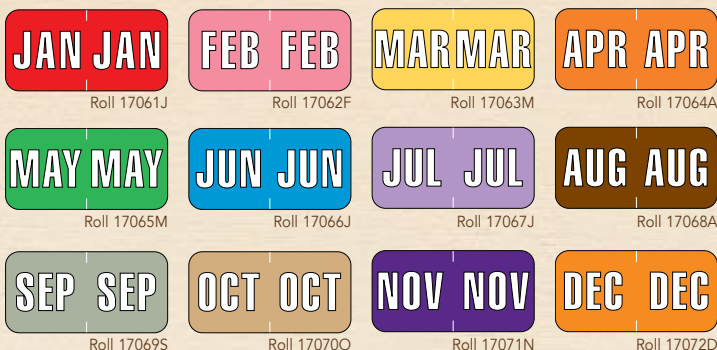

18600 Series

Tab® 1279 Compatible
 $\frac{1}{2}$ " H x 1" W (Vinyl)



Name Labels and Protectors

7000 Series

Pressure-Sensitive 3½" W x 5/8" H

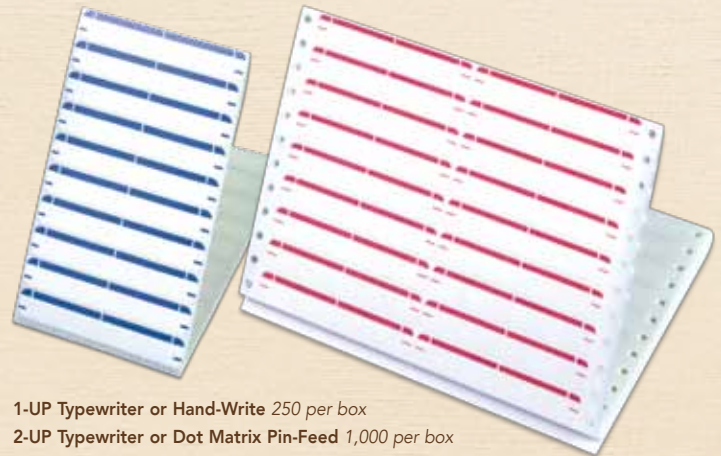

1-UP Typewriter or Hand-Write 250 per box
2-UP Typewriter or Dot Matrix Pin-Feed 1,000 per box

White Name Labels



Typewriter-Spaced Name Labels
7035W 250 labels/roll, 3½" W x 5/8" H

1-UP Dot Matrix Pin-Feed
7020W 5,000 labels, 3½" W x 9/16" H
7025W 5,000 labels, 3½" W x 13/16" H
(fits 4 lines of type)

2-UP Dot Matrix Pin-Feed Mini Label
7030W 1,000 labels, 2½" W x 5/8" H
(for use with mini file folder/pocket)

LNL Series

2-UP Laser Printer Labels 37/16" W x 9/16" H

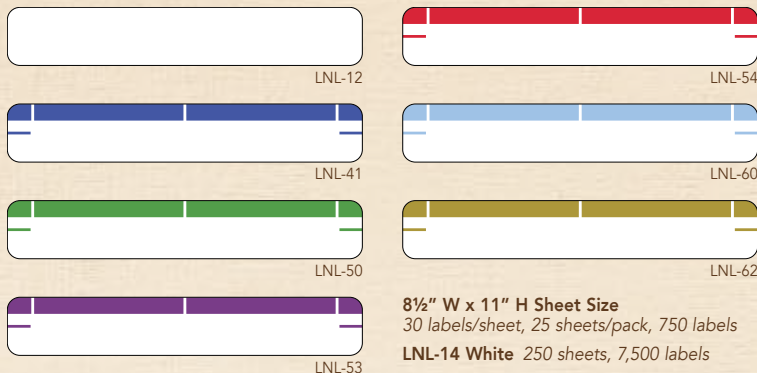

8½" W x 11" H Sheet Size
30 labels/sheet, 25 sheets/pack, 750 labels
LNL-14 White 250 sheets, 7,500 labels

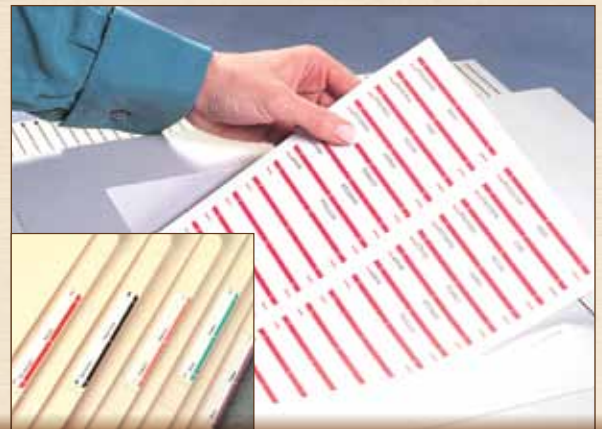

7500 Series (clear)

Clear Mylar Label Protectors, 3½" protects name label, 8" length protects full tab

- Adds durability
- Protects typed name labels from smudging
- Wraparound design
- Repairs worn chart tabs or spines
- Solid color or color stripe also available (*below*) for additional color-coding designation

ITEM NO.	QTY	DIMENSIONS BEFORE FOLDING
7500TP	500	3½" W x 1¾" H
7510TP	100	8" W x 1¾" H
7550TP/500	500	8" W x 1¾" H

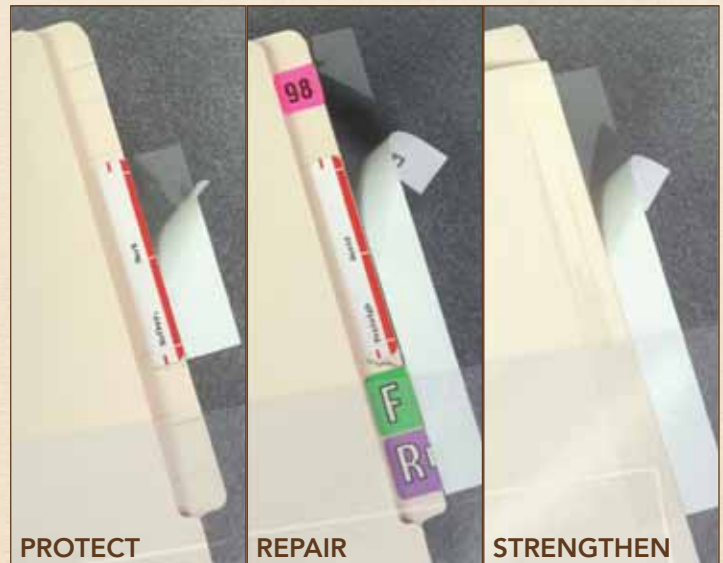

7500 Series

3½" W x 1¾" H before folding

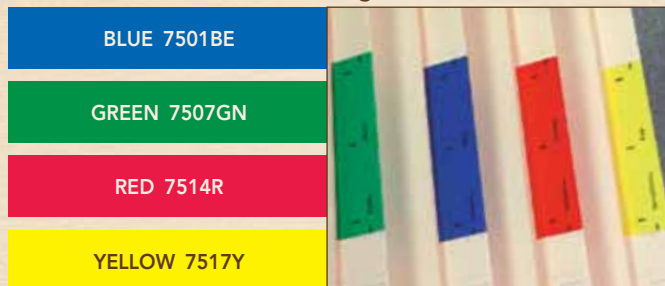

Individually packaged 500/color

7400 Series

3½" W x 2" H before folding

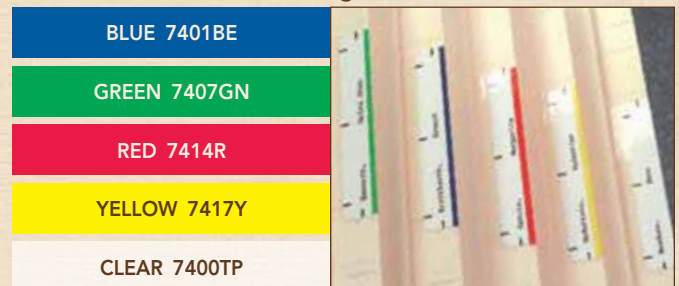

Individually packaged 500/color

FASTFIX™

Folder Reinforcer

- ◀ PROTECT
- ◀ REPAIR
- ◀ SEAL
- ◀ STRENGTHEN

2½" H x 10⅝" W applied size

- 1 Dispense 1" of a FASTFIX label.
- 2 Place exposed adhesive onto the center of the folder spine and hold down with one hand.
- 3 Without holding the box, use your other hand to pull the release strip (white paper) straight back. The box will follow and dispense one FASTFIX label.
- 4 Press firmly to secure (based on condition of the folder, a label roller may be required for good adhesion).



7590TP

CLEAR POLY

7590MTV

MANILA TYVEK



Legal filing **made easy**

Look no further for the highest-quality legal filing products available. From indexes to folders, labels to outguides, and a durable line of expandable file pockets, we've got your needs covered. Our legal filing supplies will promote streamlined efficiency and organization, helping you perform at your best.

